

CHARNWOOD

Plymouth, Michigan

Dear Co-Owner:

Welcome to Charnwood. This Purchaser's Information Booklet includes all the documents that will be helpful for your information as well as all the documents required by Michigan law for the formation of a condominium. The Purchaser's Information Booklet will serve as a reference point for any questions you may have concerning the operation, maintenance and legal status of your condominium unit.

Thank you for purchasing a condominium unit at Charnwood.

Sincerely,

CHARNWOOD GROUP

Arthur A. Savole  
James M. Burroughs

CHARNWOOD CONDOMINIUM  
INFORMATION STATEMENT

Dear Co-Owner :

The Michigan Condominium Act requires that after a permit to sell is issued by the Michigan Department of Commerce and at least nine (9) days before a condominium unit is conveyed to you or nine (9) days before a purchase agreement or reservation agreement becomes a binding agreement, the developer of the condominium shall provide to the prospective purchaser copies of the following documents relative to the condominium:

- (a) the master deed;
- (b) the bylaws of the condominium association;
- (c) disclosure statements as prescribed by the Michigan Department of Commerce;
- (d) the Condominium Buyers Handbook;
- (e) any other documents prescribed by the Michigan Department of Commerce.

The time limits prescribed by the Act may be waived in exceptional cases by a purchaser who is provided all of the aforementioned documents and waives in writing on a form approved by the Michigan Department of Commerce the purchaser's right to the protection provided by advance review time. The form shall include the language prescribed by the Michigan Condominium Act.

A condominium developer who does not meet the foregoing requirements of the Michigan Condominium Act, in addition to other liabilities and penalties, is liable to the purchaser of a condominium unit for damages.

This form signed by you acknowledges your receipt of the documents described above and is prima facie evidence that these documents were received and understood by you.

Sincerely,

CHARNWOOD GROUP

The undersigned acknowledges receipt  
of the condominium documents described  
above.

Dated: \_\_\_\_\_

DISCLOSURE STATEMENT  
CHARWOOD CONDOMINIUM  
Plymouth, Michigan

(313) 855-0101

The effective date of this Disclosure Statement

is April 30, 1984

\* \* \* \* \*

Charwood Condominium is an 8 unit residential condominium development in Plymouth Township, Michigan, that may be expanded to include a total of approximately 52 units. The first portion of construction is scheduled for completion by approximately November, 1984.

THIS DISCLOSURE STATEMENT HAS BEEN FILED WITH THE CORPORATIONS AND SECURITIES BUREAU, MICHIGAN DEPARTMENT OF COMMERCE, 6546 MERCANTILE WAY, LANSING, MICHIGAN 48910. THE DEPARTMENT HAS NOT UNDERTAKEN TO PASS ON THE VALUE OR MERITS OF THE DEVELOPMENT NOR TO MAKE ANY RECOMMENDATIONS AS TO THE PURCHASE OF UNITS IN THIS DEVELOPMENT.

THIS DISCLOSURE STATEMENT IS NOT A SUBSTITUTE FOR THE MASTER DEED, THE CONDOMINIUM BUYER'S HANDBOOK OR OTHER LEGAL DOCUMENTS, AND ALL BUYERS SHOULD READ ALL DOCUMENTS TO FULLY ACQUAINT THEMSELVES WITH THE PROJECT AND THEIR RIGHTS AND RESPONSIBILITIES RELATING THERETO.

WE RECOMMEND THAT YOU SEEK PROFESSIONAL ASSISTANCE PRIOR TO PURCHASING A CONDOMINIUM UNIT.

Developer:

Charwood Group  
27830 Orchard Lake Road  
Suite #203  
Farmington Hills, Michigan 48018

TABLE OF CONTENTS

I. Size and Scope of the Development . . . . .	1
II. Warranty. . . . .	2
III. Escrow Arrangement. . . . .	2
IV. Expandable Condominium. . . . .	3
V. Management of the Condominium Association . . . . .	4
VI. Budget and Assessments. . . . .	6
VII. Restrictions Applicable to the Condominium. . . . .	7
VIII. Developer's Background and Experience . . . . .	8
IX. Legal and Administrative Proceedings. . . . .	8
X. Insurance . . . . .	8
XI. Roads, Parking and Easements. . . . .	9
XII. Possible Liability of Co-Owners for Additional Assessments. .10	
XIII. Purpose of Disclosure Statement . . . . .	.10
Appendix A - Initial Estimated Budget	

I. Size and Scope of the Development.

Charnwood Condominium is situated in the Township of Plymouth, Wayne County, Michigan. The development consists of 8 residential condominium units that may be expanded to include a total of approximately 52 units in additional phases. The 8 units are situated on approximately 1.92 acres of land. No recreational or community facilities are planned.

The Condominium Act of Michigan requires developer to label the structures and improvements on the condominium plan as either "must be built" or "need not be built". Each purchase agreement provides that developer is not contractually obligated to construct any of the "need not be built" units. However, each purchase agreement also provides that if developer fails to complete the unit substantially in accordance with the plans and specifications within a certain time period stated in each agreement, then the purchaser may withdraw from the purchase agreement without penalty and receive back any deposit. A purchaser who closes upon the purchase of a completed unit is given no assurance that any other improvements or structures designated "need not be built" will be completed by developer. Developer has not provided financial arrangements for the completion of any structures or improvements.

The land, walkways, roads, common utility systems, and structural elements of the buildings are all general common elements owned and used in common by all co-owners. Each co-owner of a unit will own a fractional interest (1/100) in the common elements. Individual owners may also have the exclusive right to use certain limited common elements such as balconies and porches. The general common elements and the unit dimensions of each condominium unit are described in the condominium subdivision plan and in the condominium master deed. These documents should be carefully reviewed by each purchaser, and in this respect, each purchaser is advised to consult legal counsel.

## II. Warranty.

Developer will warrant to each purchaser of a condominium unit that the unit and the common elements will be free from defects in material and workmanship. The warranty on each unit shall extend for a period of one year after the closing of the purchase of the unit and shall be effective only for defects of which written notice is given by the unit owner to the developer within the one year period. The warranty on common elements extends for a period of one year, which period begins with the construction of the common element or with the closing of the purchase of the first unit in the development whichever date is later. In order for this warranty on the common elements to be effective, notice of any defect in the common elements must be given to the developer within the one year period. There are no exclusions in the foregoing warranty. The warranty is non-transferable. The developer will be primarily responsible under the terms of the warranty and will not require co-owners during the warranty period to resort to the underlying warranties provided by subcontractors and/or manufacturers. In the event of a warranty claim, co-owners should contact directly, in writing, Charnwood Group, 27830 Orchard Lake Road, Suite #203, Farmington Hills, Michigan 48018 (Phone: (313) 855-0101).

## III. Escrow Arrangement.

Developer entered into an escrow agreement with American Title Insurance Company which provides that all deposits made under purchase agreements be placed in escrow. The escrow agreement provides for the release of an escrow deposit to any purchaser who withdraws from a purchase agreement in accordance with the purchase agreement. Such a withdrawal is permitted by each purchase agreement if it takes place within nine business days after the purchaser has received all of the condominium documents, or if the purchase agreement is conditional upon obtaining a mortgage and purchaser is unable to do so, or if the unit is not completed within the time period stated in the purchase agreement, or if the condominium documents are changed in a way that materially reduces a purchaser's rights.

The escrow agreement also provides that a deposit will be released to the developer if the purchaser defaults in any obligation under the purchase agreement after the purchase agreement has become binding upon the purchaser. The escrow agreement also provides that deposits will be released to the developer when: (a) the closing of the sale takes place, and (b) a certificate of occupancy is issued if required by local ordinance, and (c) if any structures or improvements on the condominium plan are labeled "must be built", the escrow agent has received certification from an engineer or architect that such structures or improvements are substantially complete.

#### IV. Expandable Condominium.

In the master deed developer has reserved the right to expand the condominium by adding all or portions of an area of land adjacent to the condominium which is described in the master deed and by building additional units and common elements upon that land. Developer is not obligated to make any such expansions. Developer has reserved the right to add up to an additional 44 units for a maximum of 52 units in the Condominium. However, developer only has local site plan approval for construction of 18 units and does not intend to build more than 52 units unless unforeseen circumstances cause the site plan to be changed. If the condominium is expanded, it will be done by an amendment to the master deed. Such amendments will recalculate percentages of value so that the total of percentages continues to equal 100. Any such amendment would also define and assign new common elements, which would be completely within developer's discretion. Such amendments will not require the consent of any of the condominium unit owners or their mortgagees. The master deed imposes no restrictions upon the manner or order in which parcels may be added to the condominium, nor upon the location or design of units, common elements or other improvements which may be added to the condominium, all of which matters are reserved solely within the discretion of the developer, except that any such additional improvement must be solely for residential use and must comply with all applicable laws, ordinances, and requirements of local building authorities. The developer's right to amend the master deed

to expand the condominium expires six years after the first master deed has been recorded.

V. Management of the Condominium Association.

The common affairs of the co-owners and all matters relating to the common elements of the condominium will be managed exclusively by Charnwood Condominium Association, a Michigan non-profit corporation. As each individual purchaser acquires title to a condominium unit, the purchaser will also become a member of the condominium association. The manner in which the association will be run by its members, its officers and its board of directors is carefully set forth in the condominium bylaws which are attached to the master deed as Exhibit A and in the corporate bylaws and articles of incorporation which are included in each purchaser's Ownership Booklet.

The bylaws of the condominium association permit the association to hire a professional management company to manage the affairs of the association. Prior to the time the association is turned over to its members at its first annual meeting, the association may be managed by Continental Mortgage and Realty Company, an experienced management company which is affiliated with the developer. The management fee shall be at the rate of \$6.00 per month per occupied unit. This management agreement is for a one-year term but may be terminated by either party upon 60 days written notice.

The following provisions shall apply notwithstanding the fact that the first annual meeting may not have been called:

(a) An advisory committee of nondeveloper co-owners shall be established either one hundred twenty (120) days after conveyance of legal or equitable title to nondeveloper co-owners of one-third (1/3) of the units that may be created, or one (1) year after the initial conveyance of legal or equitable title to a nondeveloper co-owner of a unit in the project, whichever occurs first. The advisory committee shall meet with the condominium project board of directors for the purpose of facilitating communication and aiding the transition of control to the association of co-owners. The



advisory committee shall cease to exist when a majority of the board of directors of the association of co-owners is elected by the nondeveloper co-owners.

(b) Not later than one hundred twenty (120) days after conveyance of legal or equitable title to nondeveloper co-owners of twenty-five (25%) percent of the units that may be created, at least one (1) director and not less than twenty-five (25%) percent of the board of directors of the association of co-owners shall be elected by nondeveloper co-owners. Not later than one hundred twenty (120) days after conveyance of legal or equitable title to nondeveloper co-owners of fifty (50%) percent of the units that may be created, not less than thirty-three and one-third (33-1/3%) percent of the board of directors shall be elected by nondeveloper co-owners. Not later than one hundred twenty (120) days after conveyance of legal or equitable title to nondeveloper co-owners of seventy-five (75%) percent of the units that may be created, and before conveyance of ninety (90%) percent of such units, the first annual meeting shall be called and the nondeveloper co-owners shall elect all directors on the board, except that the Developer shall have the right to designate at least one (1) director as long as the Developer owns and offers for sale at least ten (10%) of the units in the project or as long as ten (10%) percent of the units remain that may be created.

(c) Notwithstanding the formula provided in subsection (b), 54 months after the first conveyance of legal or equitable title to a non-developer co-owner of a unit in the project, if title to not less than seventy-five (75%) percent of the units that may be created has not been conveyed, the first annual meeting shall be called and the nondeveloper co-owners have the right to elect as provided in the condominium documents, a number of members of the board of directors of the association of co-owners equal to the percentage of units they hold, and the Developer has the right to elect as provided in the condominium documents, a number of members of the board equal to the percentage of units which are owned by the Developer and for which all assessments are payable by the Developer.

This election may increase, but shall not reduce, the minimum election and designation rights otherwise established in subsection (b). Application of this subsection does not require a change in the size of the board as determined in the condominium documents.

(d) If the calculation of the percentage of members of the board that the nondeveloper co-owners have the right to elect under subsection (b), or if the product of the number of members of the board multiplied by the percentage of units held by the nondeveloper co-owners under subsection (c) results in a right of nondeveloper co-owners to elect a fractional number of members of the board, then a fractional election right of 0.5 or greater shall be rounded up to the nearest whole number, which number shall be the number of members of the board that the nondeveloper co-owners have the right to elect. After application of this formula the Developer shall have the right to elect the remaining members of the board. Application of this subsection shall not eliminate the right of the Developer to designate one (1) member as provided in subsection (b).

(e) As used in this section, the term "units that may be created" means the maximum of units in all phases of the Condominium as stated in the Master Deed.

#### VI. Budget and Assessments.

The budget required to conduct the business of the association has been estimated on an annual basis by the developer. A copy of this estimated budget is attached to this disclosure statement as Appendix A. The initial condominium assessments charged to members are based upon this budget. However, it must be kept in mind that this is an estimate only and there can be no guarantee that the budget will be sufficient to meet the expenses of the association. The association's only source of revenue to fund its budget is by the assessment of its members. Each member co-owner of the association must pay to the association an annual assessment which is determined by dividing the projected budget by the member's percentage of value which is stated in the master deed. According to the master deed, every member has the same percentage of value which is equal to 1/100. The annual and monthly assessments to be paid by each member during the first year of operation of the association is estimated on the attached budget.

In the event the association incurs expenses which are not anticipated in the budget, the association may also levy special assessments to cover such expenses. Any special assessments would be apportioned among the co-owners in accordance with the percentage of value stated in the master deed. If any co-owner becomes delinquent in paying any assessments, then, under certain circumstances, the delinquency might be spread among the remaining co-owners. Before the first annual meeting of the co-owners, the developer will not pay association assessments but will pay for the maintenance and insurance of its own units. The developer will only pay regular monthly assessments after the first annual meeting for completed units owned by developer.

VII. Restrictions Applicable to the Condominium.

Owners of condominium units will be bound by various restrictions applying to the use of the condominium units and common elements. These restrictions are found in the master deed and in the condominium bylaws (particularly in article VI of the condominium bylaws) and these documents should be carefully reviewed. For example, article VI of the condominium bylaws prohibits commercial activities on the premises, prohibits alterations in the exterior appearance or structure of any unit, prohibits immoral, improper, unlawful, offensive or unreasonably noisy activities on the premises, regulates the number of pets which may be kept on the premises, regulates the kind of vehicles which may be parked on the premises, prohibits the use of "for sale" signs without the permission of the board of directors of the association, gives access to the association to all units and common elements for the purpose of their protection and repair, prohibits landscaping upon the common elements without association approval, prohibits unsightly conditions on any balcony, and permits the association board of directors to adopt further reasonable regulations concerning the use of the units and the common elements. The foregoing does not constitute an exhaustive list of restrictions pertaining to the condominium and the master deed and condominium bylaws should be carefully reviewed in this respect. None of the foregoing restrictions prohibit the developer from carrying on sales activities as long as the developer is selling units in the condominium.

VIII. Developer's Background and Experience.

Charnwood Group is a newly formed Michigan Co-Partnership consisting of Arthur A. Savoie and Associates, Inc. and J.M.B. and Associates, Inc., the principals of which are Arthur A. Savoie and James M. Burroughs who have had substantial experience in the development, building, sales and financing of various single family homes, condominiums, rental and commercial properties. Mr. Savoie is a licensed real estate broker and builder and Mr. Burroughs a licensed real estate broker and real estate appraiser.

IX. Legal and Administrative Proceedings.

There are no legal or administrative proceedings pending which involve the construction, development or sale of Charnwood Condominium.

X. Insurance.

The condominium development will be insured against fire and other casualty under a master insurance policy which will name the Charnwood Condominium Association as the Insured. In the event of any casualty affecting the condominium buildings, the insurance proceeds would be paid to and administered by the condominium association in accordance with the provisions of the condominium bylaws. The insurance coverage which will be carried by the condominium association will not cover the interior of any individual unit or any personal property of any co-owner. Each unit owner should acquire insurance on the interior of the owner's unit and on the owner's personal property.

As of the effective date of this disclosure statement, the insurance coverage on the condominium buildings is in the name of the developer under the developer's builders risk policy. The policy insuring the condominium association will not take effect until sales commence. Until that time, the developer cannot determine what the exact limits of coverage of the policy will be or what insurance agency or company will produce the policy. The developer expects such a policy to be in the approximate face amount of the aggregate sales price of the units less the value of the land and improvements which are not subject to destruction by fire or other

hazards. Nor can the developer determine in advance what the exact amount of the deductible clause in the policy will be but it is customary that such deductible clauses are in the amount of \$500.00. At the time hazard insurance is obtained in the name of the condominium association, developer agrees that a summary of the terms of the insurance policy shall be set forth in a supplement to this disclosure statement which shall be distributed to all purchasers.

Title insurance will be supplied each individual purchaser as the sales of the units are consummated. These title insurance policies will be ordered by the developer at its own expense upon the closing of each sale. The policies will be in the face amount of the purchase price of each unit. The title policies will be issued by American Title Insurance Company or any other title insurer authorized to do business in the State of Michigan. The policies will insure each purchaser that the purchaser's title to the unit received from the developer is in the condition required by each purchase agreement.

#### XI. Roads, Parking and Easements.

The roads and general parking areas of the condominium are general common elements of the development and are not public roads. The roads will not be maintained, cleared, repaired or patrolled by any public authority. The expenses associated with the roads will be borne by the condominium association and therefore paid by the co-owners in accordance with their percentages of value. The roadway will be asphalt and will require some routine maintenance. It is impossible to estimate how much maintenance might be required in any given year. The roadway is being constructed in 1984. With normal use and maintenance, such a roadway would have an estimated useful life of at least 15 years prior to any major resurfacing being required. None of the foregoing statements about the roads are warranties or promises made by the developer to any co-owner or the condominium association regarding the condition of the road, its normal useful life, or the cost of maintenance or resurfacing.

The condominium premises will be subject to a number of easements.

The master deed describes certain reciprocal easements granted to condominium co-owners and to the condominium association. There are also easements relating to utility services which will be described in each title insurance commitment and title insurance policy. Purchasers are advised to have title insurance commitments reviewed by their attorneys prior to closing. The master deed also permits the developer to maintain offices, model units and sales facilities in the condominium during the period of development and sales.

#### XII. Possible Liability of Co-Owners for Additional Assessments.

It is possible for co-owners to become obligated to defray assessment delinquencies incurred by other co-owners. This can happen if the delinquent co-owner defaults on the first mortgage on a co-owner's unit, and if the mortgagee forecloses and becomes the owner of the unit. Any person who becomes the owner of a condominium unit by foreclosing a first mortgage on the unit takes that unit free of the delinquent assessments the mortgagor may have owed to the condominium association. The unpaid assessment then becomes a common expense which is reallocated to all the co-owners, including the first mortgagee, in accordance with the percentages of value in the master deed.

#### XIII. Purpose of Disclosure Statement.

This disclosure statement was prepared by developer in compliance with the Michigan Condominium Act. This statement paraphrases various provisions of the purchase agreement, escrow agreement, master deed, and other documents required by law. This statement only highlights certain provisions of such documents and by no means contains a complete statement of all the provisions of those documents which may be important to purchasers. In an attempt to be more readable, this statement omits most legal phrases, definitions and detailed provisions of the other documents. This statement is not a substitute for the legal documents which it draws information from, and the rights of purchasers and other parties will be controlled by the other legal documents and not by this disclosure statement. All the documents referred to

In this statement should be carefully reviewed by prospective purchasers, and it is advisable to have professional assistance in making this review.

Developer is required by law to prepare this statement. However, developer disclaims liability to any purchaser for misstatements herein (or for omissions which make statements herein appear misleading) if such misstatements were made by developer in good faith, or were immaterial in nature, or were not relied upon by the purchaser, or did not result in any damages to the purchaser. Developer is required to give each purchaser a copy of The Condominium Buyers Handbook. This handbook was prepared by the Michigan Department of Commerce, and developer accepts no responsibility for its contents.

CHARRWOOD BUDGET

MANAGEMENT FEE . . . . .	\$ 576.00
LEGAL AND ACCOUNTING . . . . .	200.00
GROUNDS EXPENSE:	
Snow Removal . . . . .	320.00
Lawn Care . . . . .	900.00
COMMON AREA ELECTRIC . . . . .	200.00
WATER . . . . .	500.00
BUILDING MAINTENANCE . . . . .	250.00
REFUSE REMOVAL . . . . .	300.00
INSURANCE . . . . .	500.00
GENERAL RESERVE . . . . .	<u>420.00</u>
ANNUAL REQUIREMENT . . . . .	\$ 4,166.00
MONTHLY REQUIREMENT . . . . .	\$ 347.16
PER UNIT REQUIREMENT:	
One (1) Bedroom . . . . .	\$ 37.31
Two (2) Bedroom . . . . .	\$ 49.48

APPENDIX A



MASTER DEED

CHARWOOD CONDOMINIUM

Wayne County Condominium Subdivision Plan No. 190

This Master Deed is made and executed this 12th day of June, 1984, by Charwood Group, a Michigan Co-Partnership, (hereinafter referred to as "Developer") whose address is 27830 Orchard Lake Road, Suite 203, Farmington Hills, Michigan 48018.

W I T N E S S E T H :

WHEREAS, Developer desires by recording this Master Deed, together with the Condominium Bylaws attached hereto as Exhibit A and together with the Condominium Subdivision Plan attached hereto as Exhibit B (both of which are hereby incorporated by reference and made a part hereof), to establish the real property described in Article II below, together with the improvements located and to be located thereon, and the appurtenances thereto, as a condominium under the provisions of the Condominium Act of Michigan.

NOW, THEREFORE, Developer does, upon the recording hereof; establish Charwood Condominium as a condominium under the Condominium Act and does declare that Charwood Condominium shall, after such establishment; be held, conveyed, hypothecated, encumbered, leased, rented, occupied, improved, or in any other manner utilized, subject to the provisions of said Act, and to the covenants, conditions, restrictions, uses, limitations, and affirmative obligations set forth in this Master Deed and the Exhibits hereto, all of which shall be deemed to run with the land and shall be a burden and a benefit to the developer, its successors and assigns, and any persons acquiring or owning an interest in the said real property, their grantees, successors, heirs, executors, administrators and assigns.

ARTICLE I

TITLE AND NATURE

The Condominium shall be known as Charwood Condominium, Wayne County Condominium Subdivision Plan No. 190. The architectural plans and specifications for the Condominium were filed with the Charter Township of Plymouth. The buildings and units contained in the Condominium, including the number, boundaries, dimensions and volume of each unit therein are set forth completely in the Condominium Subdivision Plan attached as Exhibit B hereto. Each building contains individual units for residential purposes only and each unit is capable of individual use, having its own entrance from and exit to a common element of the Condominium. Each co-owner in the Condominium shall have an exclusive right to his or her unit and shall have undivided and inseparable rights to share with other co-owners the common elements of the Condominium as are designated by the Master Deed. Co-owners shall have voting rights in the Charwood Condominium Association as set forth herein, in the Condominium Bylaws, Corporate Bylaws and Articles of Incorporation of such Association. Nothing in this Master Deed shall be construed to impose upon Developer any contractual or other legal obligation to build, install or deliver any structure or improvement which is labeled on the Plan (Exhibit B) as "need not be built."

ARTICLE IILEGAL DESCRIPTION

The land which is submitted to the Condominium established by this Master Deed is described as follows:

Land in the Charter Township of Plymouth, Wayne County, Michigan being described as:

A portion of Lot 48, Supervisor's Plymouth Plat No. 3 of Holcomb's Addition to the Village of Plymouth and part of Section 23, T1S, R8E, Plymouth Township, Wayne County, Michigan, as recorded in Liber 66, Page 38 of Plats, Wayne County Records.

Described as: Beginning at a point on the south line of said Lot 48 distant S. 89°36'20" E. 28.20 feet from the southwest corner of said Lot 48; thence northerly an arc distance of 151.48 feet along a curve concave to the east through a central angle of 3°27'43" to the end of said curve; thence N. 13°01'20" W. 92.06 feet to the north line of said Lot 48; thence S. 89°35'20" E. 383.32 feet along said north line; thence S. 00°06'45" E. 235.64 feet to the south line of said Lot 48; thence N. 89°36'20" W. 324.47 feet to the point of beginning. Containing 1.92 acres of land.

DESCRIPTION OF RIGHT OF WAY to be dedicated to the Wayne County Road Commission for Northville Road

A portion of Lot 48, Supervisor's Plymouth Plat No. 3 of Holcomb's Addition to the Village of Plymouth and part of Section 23, T1S, R8E, Plymouth Township, Wayne County, Michigan, as recorded in Liber 66, Page 38 of Plats, Wayne County Records.

Described as: Beginning at the southwest corner of Lot 48 of said subdivision; thence northerly along the west lot line of Lot 48, an arc distance of 144.92 feet along a curve concave to the east having a radius of 2534 feet through a central angle of 3°16'37" to the end of said curve; thence N. 13°01'20" W. 98.51 feet to the northwest corner of said Lot 48; thence S. 89°35'20" E. 27.76 feet along the north lot line; thence S. 13°01'20" E. 92.06 feet to the beginning of a curve concave to the east having a radius of 2507 feet; thence southerly 151.48 feet along said curve through a central angle of 3°27'43" to the south line of said Lot 48; thence N. 89°36'20" W. 28.20 feet along said south line to the point of beginning. Containing 0.15 acres of land.

ARTICLE IIIDEFINITIONS

Certain terms used in this Master Deed and the Exhibits hereto, and in the articles of Incorporation and corporate bylaws of the Charwood Condominium Association shall be defined as follows:

- (a) The "Condominium Act" or "Act" means Act 59 of the Public Acts of Michigan of 1978, as amended, including the amendments of Act 538 of the Public Acts of 1982. If any provision of this Master Deed or its exhibits is found to conflict with any provision of the Act, or if any provision required by the Act is omitted herefrom, then the provisions of the Act are incorporated herein by reference and shall supercede and cancel any conflicting provision hereof.

- (b) "Developer" means Charnwood Group, a Michigan Co-partnership, its successors or assigns, all rights reserved to Developer herein expressly being assignable in writing.
- (c) "Association" or "Association of Co-Owners" shall mean the Michigan non-profit corporation, Charnwood Condominium Association, of which all co-owners shall be members, which corporation shall administer, operate, manage and maintain the Condominium. Any action required of or permitted to the Association shall be exercisable by its Board of Directors unless specifically reserved to its members by the Condominium Documents or the laws of the State of Michigan.
- (d) "Condominium Bylaws" means Exhibit A hereto, being the bylaws setting forth the substantive rights and obligations of the co-owners.
- (e) "Corporate Bylaws" means the corporate bylaws of the Association, as distinguished from the Condominium Bylaws.
- (f) "Apartment" or "Unit" or "condominium unit" each mean the enclosed space constituting a single complete residential unit designed and intended for separate ownership and use in Charnwood Condominium as such space may be described on Exhibit B hereto.
- (g) "Condominium Documents", wherever used, means and includes this Master Deed and the Exhibits hereto, the articles of incorporation and the corporate bylaws of the Association.
- (h) "Condominium" means Charnwood Condominium as a condominium established pursuant to the provisions of the Act, and includes the land and the buildings, all improvements and structures thereon, and all easements, rights and appurtenances belonging to the Condominium.
- (i) "Condominium Subdivision Plan" or "Plan" means the plan attached to this Master Deed as Exhibit B. The Plan assigns a number to each condominium unit and includes a description of the nature, location and approximate size of certain common elements.
- (j) "Co-Owner" or "Owner" means a person, firm, corporation, partnership, association, trust or other legal entity or any combination thereof who or which owns one or more units in the Condominium. Developer is an Owner as long as Developer owns one or more units.
- (k) "Common Elements" means the portions of the condominium other than the condominium units.
- (l) "General Common Elements" means the common elements other than the limited common elements.
- (m) "Limited Common Elements" means a portion of the common elements reserved in this Master Deed for the exclusive use of less than all of the co-owners.

- (n) "Master Deed" means this document which, when recorded, shall establish the Condominium and to which the Condominium Bylaws and Condominium Subdivision Plan are attached as exhibits.
- (o) "Mortgagee" means the named mortgagee or owner of any mortgage on all or any portion of the Condominium premises and includes the United States Department of Housing and Urban Development, or any successor thereto or assignee thereof, so long as any mortgage on all or any portion of the Condominium premises is insured by the Department of Housing and Urban Development.
- (p) "Percentage of Value" means the percentage assigned to each condominium unit in Article VI of this Master Deed. The percentage of value of all units shall total one hundred (100%) percent. Percentages of value shall be determinative only with respect to those matters to which they are specifically deemed to relate either in the condominium documents or in the Act.
- (q) "Person" means an individual, firm, corporation, partnership, association, trust, the state or an agency of the state or other legal entity, or any combination thereof.
- (r) "Record" means to record pursuant to the Laws of the State of Michigan relating to the recording of deeds.
- (s) "Size" means the number of square feet of ground or floor space within each condominium unit as computed by reference to the Condominium Subdivision Plan and rounded off to a whole number.
- (t) "Transitional Control Date" means the date on which the Board of Directors of the Association takes office pursuant to an election in which the votes which may be cast by eligible co-owners unaffiliated with the Developer exceed the votes which may be cast by the Developer.

ARTICLE IV

COMMON ELEMENTS

The common elements of the Condominium described in Exhibit B attached hereto and the respective responsibilities for maintenance, decoration, repair, replacement, restoration or renovation thereof are as follows:

- (a) The general common elements are:
  - (1) The land described in Article II hereof, including roads and unassigned parking areas;
  - (2) The electrical system throughout the Condominium, including that contained within unit walls up to the point of connection with electrical outlets within any unit;
  - (3) The gas transmission lines throughout the Condominium, including that contained within unit walls up to the point of connection with gas fixtures within any unit;

- (4) The telephone wiring network throughout the Condominium, including that contained within unit walls up to the point of connection with telephone equipment within any unit;
- (5) The plumbing network throughout the Condominium, including that contained within unit walls up to the point of connection with plumbing fixtures within any unit;
- (6) Foundations, supporting columns, unit perimeter walls (including windows and doors therein) and such other walls as are designated on the Plan as general common elements, roofs, ceilings, floor construction between unit levels and chimneys;
- (7) The cable television transmission system, if any is installed, throughout the Condominium, including that contained within any unit walls up to the point of connection with outlets within any unit;
- (8) Such other elements of the Condominium not herein designated as general or limited common elements which are not enclosed within the boundaries of a unit.
- (b) The limited common elements are:
- (1) Each numbered carport shown on the Plan is limited to the sole use of the owner of the correspondingly numbered unit; provided, that in any expansion or contraction of the Condominium, Developer reserves the right to relocate and/or reassign carports. In the event of any such relocation or reassignment, any sold unit having a carport assigned to it on the Plan shall have a carport of similar size and quality reassigned to it;
- (2) Carports, patio areas, stairways, balconies, attic areas, and porches designated on the Plan as limited common elements are limited to the sole use of the owners of the units to which such common elements are shown as appurtenant on the Plan;
- (3) Interior surfaces of unit perimeter walls (including windows and doors therein), ceilings and floors contained within a unit are limited to the sole use of the owner of such unit.
- (c) Maintenance, repair, replacement, renovation or restoration of all general and limited common elements shall be the responsibility of the Association, except as provided herein. The limited common elements described in Article IV (b) (3) above shall be decorated and maintained (but not repaired, renovated or replaced) by the owner having the use thereof. Repair of any damage to common elements caused by a co-owner or the family or invitees of a co-owner shall be the obligation of the co-owner. Any such repair of damages may be made by the Association and charged to the co-owner. Notwithstanding the foregoing, the expense of lighting, operating, decorating, maintaining or repairing front balconies and stairs shall be specially assessed by the Association equally to all owners of all units within all buildings having such common elements, which special assessment shall be in addition to any other regular or special assessments levied by the Association.

ARTICLE V

L122045PA538

USE OF PREMISES

No co-owner shall use his or her unit or the common elements in any manner inconsistent with the purposes of the Condominium or in any manner which will interfere with or impair the rights of any other co-owner in the use and enjoyment of his or her unit or the common elements.

ARTICLE VI

CONDOMINIUM UNIT DESCRIPTION AND PERCENTAGE OF VALUE

A. The Condominium consists of eight (8) units. Each condominium unit is described in this paragraph with reference to the Condominium Subdivision Plan attached hereto as Exhibit B. Each condominium unit shall include all that space contained within the interior side of the finished, unpainted perimeter walls, and within the ceilings and finished subfloor, all as shown on Exhibit B and delineated with heavy outlines. For all purposes, individual units may hereafter be defined and described by reference to this Master Deed and the individual number assigned to the unit in the Condominium Subdivision Plan.

B. The percentage of value assigned to each unit is set forth in this Article and shall be determinative of the proportionate share of each respective co-owner in the proceeds and expenses of the administration (except as provided in Article IV (c) above) and the value of such co-owner's vote at meetings of the Association and the undivided interest of the co-owner in the common elements. The total percentage value of the Condominium is 100%. Individual unit percentages of value shall be as follows:

Schedule of Percentages of Value

<u>Unit Numbers</u> <u>According to Plan</u>	<u>Percentage</u> <u>For Each Unit</u>
Units 1, 4, 5 & 8	10.746%
Units 2, 3, 6 & 7	14.254%

The method used by Developer to determine the foregoing percentages was to determine that the allocable expenses of maintenance for each unit should be approximately equal after adjustments for the special assessments provided in Article IV (c) above. The formula used by Developer was to arrive at the total square footage of the building and of the individual units and to divide to three decimal places the individual unit total by the building total.

ARTICLE VII

EASEMENTS

In the event any portion of a unit or common element encroaches upon another unit or common element due to shifting, settling, or moving of a building, or due to survey errors or construction deviations, reconstruction or repair, reciprocal easements shall exist for the maintenance of such encroachment for so long as such encroachment exists, and for maintenance thereof after rebuilding in the event of any destruction. There shall be easements to, through and over those portions of the land, structures, buildings, improvements and walls (including interior unit walls) contained therein for the installation, maintenance and servicing of all utilities in the Condominium, including, but not limited to, lighting, heating, power, sewer, water and communications including telephone and cable television lines. There shall exist easements of support with respect to any unit interior wall which supports a common element. The Board of Directors of the Association may grant easements over or through, or dedicate, any portion of any general common element of the Condominium for utility, roadway, construction or safety purposes, and during the construction of the Condominium the Developer may grant such easements or dedications over all common elements for the purpose of developing the Condominium. Developer also reserves all easements granted by the Act, without restriction of any kind.

## ARTICLE VIII

EXPANDABLE AND CONTRACTABLE CONDOMINIUM

Charnwood Condominium is established as an expandable and contractable condominium in accordance with the provisions of this Article VIII:

- (a) Developer reserves the right, but not an obligation to expand and/or contract the Condominium.
- (b) There are no restrictions or limitations on Developer's right to expand or contract the Condominium except as stated in this Article VIII. The consent of any co-owner shall not be required to expand or contract the Condominium. All of the co-owners and mortgagees of units and persons interested or to become interested in the Condominium from time to time shall be deemed to have irrevocably and unananimously consented to such expansion or contraction of the Condominium and any amendment or amendments to this Master Deed to effectuate the expansion or contraction and to any reallocation of percentages of value of existing units which Developer may determine necessary in conjunction with such amendment or amendments. All such interested persons irrevocably appoint Developer or its successors as agents and attorney for the purpose of executing such amendment or amendments to the Master Deed and all other documents necessary to effectuate the foregoing. Such amendments may be made without the necessity of rerecording an entire Master Deed or the Exhibits thereto and may incorporate by reference all or any pertinent portions of this Master Deed and the Exhibits herein. Nothing herein contained, however, shall in any way obligate Developer to enlarge or contract the Condominium and Developer may, in its discretion, establish all or a portion of the Additional Land described herein as a rental development, a separate condominium, or any other form of development.
- (c) The Developer's right to expand or contract the Condominium project shall expire six (6) years after the initial recording of this Master Deed.
- (d) The land which may be added to the Condominium is situated in the Charter Township of Plymouth, Wayne County, Michigan and is more specifically described on Exhibit C to this Master Deed, which exhibit is incorporated in this subparagraph by reference. The land described in Exhibit C is contiguous and adjacent to the Condominium and may herein be referred to as "Additional Land." Any land withdrawn from the Condominium by a contraction shall be included within the definition of "Additional Land" for all purposes in this Master Deed and may or may not be added back to the Condominium in a subsequent expansion.
- (e) The Additional Land may be added to the Condominium in its entirety or in parcels, in one amendment to this Master Deed or in successive amendments to this Master Deed at the same time or at different times in the Developer's discretion. There are no restrictions upon the order in which portions of the Additional Land may be added to the Condominium. The land which may be withdrawn may be withdrawn as one parcel or in separate parcels at different times in any order, the boundaries of which separate parcels shall include one or more buildings and all land adjacent thereto but shall exclude any land necessary to service the remaining buildings for roads, ingress and egress, and the aforesaid setback and space requirements.

- (f) There are no restrictions upon the locations of any improvements that may be made on any portions of the Additional Land, and Developer reserves the right to locate such improvements in Developer's sole discretion subject only to such applicable laws and ordinances which may affect the property.
- (g) The maximum number of units which Developer reserves the right to construct upon the Additional Land is 34, which together with the 18 units described in the Initial Master Deed equals 52 units. Local building ordinances and regulations may permit a smaller number than 34 units to be created upon the Additional Land. This Master Deed imposes no restrictions upon the number of units to be created on individual portions of the Additional Land, provided that the maximum number of units stated herein for the whole shall not be exceeded. The minimum number of units which may remain after the contraction is eight units.
- (h) One hundred (100%) percent of the Additional Land and the units to be created thereon shall be restricted exclusively to residential use and common elements (including amenities if any are hereafter constructed by Developer) as may be consistent and compatible with residential use.
- (i) The extent to which any structures erected on any portion of the Additional Land added to the Condominium are compatible with structures on land included in the original Master Deed is solely within the discretion of the Developer, subject only to the requirements of local ordinances and building authorities, and is not limited by this Master Deed.
- (j) The improvements which may be made on any portion of the Additional Land to be added to the Condominium may only be residential condominium units and such common elements as may be compatible therewith. There are no other restrictions upon such improvements except those which are imposed by state law, local ordinances or building authorities.
- (k) There are no restrictions as to types of condominium units which may be created upon the Additional Land except that such units must be for residential use and must comply with state law, local ordinance and the requirements of building authorities.
- (l) If the Condominium is expanded, it shall be expanded by an amendment to the Master Deed or by a series of successive amendments to the Master Deed, each adding Additional Land and/or improvements to the Condominium.
- (m) Developer hereby reserves permanent easements for ingress and egress over the roads and walks, if any, in the Condominium and permanent easements to use, tap into, enlarge or extend all utility lines in the Condominium, including, without limitation, all communications, water, gas, storm and sanitary sewer lines, all of which easements shall be for the benefit of the Additional Land whether or not such land is added to the Condominium. Developer has no financial obligation to support such easements.



- (n) Any amendment to the Master Deed which alters the number of units in the Condominium shall proportionately readjust the existing percentages of value of condominium units to preserve a total value of one hundred (100%) percent for the entire condominium. Percentages of value shall be readjusted and determined in accordance with the method and formula described in Article VI of this Master Deed.
- (o) Any expansion, contraction shall be deemed to have occurred at the time of the recording of an amendment to this Master Deed embodying all essential elements of the expansion, contraction or the conversion. At the conclusion of expansion of the Condominium, not later than 180 days after completion of construction, a consolidating master deed and plans showing the Condominium "as built" shall be prepared and recorded by the Developer. A copy of the recorded consolidating master deed shall be provided to the Association.

ARTICLE IX

AMENDMENTS

This Master Deed and any Exhibit hereto may be amended as provided in the Act in the following manner:

- (a) Amendments may be made and recorded by Developer or by the Association without the consent of co-owners or mortgagees if the amendment does not materially alter or change the rights of a co-owner or mortgagee and is for one or more of the purposes stated in Article IX (c) hereof. Any amendment made by the Association must be approved by the owners of a simple majority of the number of units in the Condominium (unless a greater majority is specified in the Condominium Bylaws). The Association may make no amendment without the written consent of the Developer as long as the Developer owns any units in the Condominium or has the right to enlarge the Condominium.
- (b) Except as otherwise provided herein, the Master Deed, Bylaws, and Condominium Subdivision Plan may be amended, by the Developer or the Association, even if the amendment will materially alter or change the rights of the co-owners or mortgagees, with the consent of not less than two-thirds (2/3) of the votes of the co-owners and mortgagees (unless a greater majority is specified in the Condominium Bylaws). A mortgagee shall have one vote for each mortgage held. The Association shall have amendment without the written consent of the Developer as long as the Developer owns any units in the Condominium or has the right to enlarge the Condominium.
- (c) Notwithstanding any contrary provision of this Master Deed or the Condominium Bylaws or Corporate Bylaws (but subject to the limitation of Article IX (d)), Developer reserves the right to amend materially this Master Deed or any of its exhibits for any of the following purposes:
- (1) To expand or contract the Condominium, to redefine common elements and/or adjust percentages of value in connection therewith, to redefine any converted area, to relocate, assign or reassign carports as limited common elements as heretofore provided in this Master Deed, to equitably allocate the Association's expenses among the owners and to make any other amendments specifically described and permitted to Developer in any provision of this Master Deed;

- (2) To modify the types and sizes of unsold condominium units and their appurtenant limited common elements and/or percentages of value and to modify the general common elements in the area of unsold units;
  - (3) To amend the Condominium Bylaws, subject to any restrictions on amendments stated therein;
  - (4) To correct arithmetic errors, typographical errors, survey or plan errors, deviations in construction or any similar errors in the Master Deed, Plan or Condominium Bylaws or to correct errors in the boundaries or locations of improvements;
  - (5) To clarify or explain the provisions of the Master Deed or its exhibits;
  - (6) To comply with the Act or rules promulgated thereunder or with any requirements of any governmental or quasi-governmental agency or any financing institution providing mortgages on units on the condominium premises;
  - (7) To make, define or limit easements affecting the Condominium premises;
  - (8) To record an "as-built" Condominium Subdivision Plan and/or Consolidating Master Deed and to designate any improvements shown on the Plan as "must be built", subject to any limitations or obligations imposed by the Act;
  - (9) To terminate and/or eliminate reference to any right which Developer has reserved to itself herein including without limitation the right to expand, contract or convert the Condominium.
- The foregoing amendments may be made without the consent of co-owners or mortgagees. The rights reserved to Developer herein may not be amended except by or with the consent of the Developer.
- (d) Notwithstanding any other provision of this Article IX, the method or formula used to determine the percentages of value of units in the Condominium, as described in Article VI hereof, and any provisions relating to the ability or terms under which a co-owner may rent a unit, may not be modified without the consent of each affected co-owner and mortgagee. A co-owner's condominium unit dimensions or appurtenant limited common elements may not be modified without the co-owner's consent. Carports may be relocated, assigned or reassigned as provided in Article IV (b) (1), (2) and (3) without any co-owner's consent.

ARTICLE X  
SALES FACILITIES

The Developer may maintain offices, model units and similar sales facilities in the Condominium. Developer shall pay all costs related to the use of such facilities while owned by Developer and restore the facilities to habitable status upon termination of use.

IN WITNESS WHEREOF, Developer has caused this Master Deed to be executed the day and year first above written.

WITNESSES:

*Leslie A. Rebtov*  
Leslie A. Rebtov

*Kimberlee A. Schalk*  
Kimberlee A. Schalk

CHARWOOD GROUP  
a Michigan Co-Partnership

By: *Arthur A. Savole*  
Arthur A. Savole

Its: Partner

By: *James M. Burroughs*  
James M. Burroughs

Its: Partner

STATE OF MICHIGAN )  
COUNTY OF Oakland ) ss:

The foregoing instrument was acknowledged before me this 12th day of June, 1984,

(1) by Arthur A. Savole (2) James M. Burroughs

(3) of Charwood Group (4) a Michigan Co-Partnership on behalf of the said Co-Partnership.

My commission expires  
LESLIE A. REBTOV  
Notary Public, Oakland County, MI  
My Commission Expires Oct-4, 1987

*Leslie A. Rebtov*  
Notary Public Oakland County, Michigan

Instrument  
Drafted by Arthur A. Savole

Business 27830 Orchard Lake Rd., #203  
Address: Farmington Hills, MI 48018

WHEN RECORDED RETURN TO:

CHARWOOD GROUP  
27830 Orchard Lake Road  
Suite #203  
Farmington Hills, Michigan 48018

EXHIBIT A

1/22045PA544

TO MASTER DEED

CONDOMINIUM BYLAWS

CHARWOOD CONDOMINIUM ASSOCIATION

ARTICLE I

Section 1. The Condominium shall be administered by a Michigan non-profit corporation, Charwood Condominium Association (hereinafter called the "Association") which shall be responsible for the management, maintenance, operation and administration of the common elements, easements and affairs of the Condominium in accordance with the Master Deed, these Bylaws, the Articles of Incorporation, Corporate Bylaws and duly adopted Rules and Regulations of the Association, and the laws of the State of Michigan. All co-owners in the Condominium and all persons using or entering upon or acquiring any interest in any Condominium unit or the common elements shall be subject to the provisions and terms set forth in the aforesaid Master Deed, Bylaws, Articles, Rules and Regulations, and laws. These bylaws are designated as the Condominium Bylaws and relate to the manner in which the Condominium and the common affairs of the co-owners of the Condominium units shall be administered. The Condominium is a residential development located in Charter Township of Plymouth, Wayne County, Michigan.

Section 2. Membership in the Association and voting by members of the Association shall be in accordance with the following provisions:

(a) Each co-owner, including Developer, shall be a member of the Association and no other person or entity shall be entitled to membership. Each member shall have one vote for each unit owned. If voting is by value, the value of each vote shall be the percentage assigned in the Master Deed.

(b) The share of a co-owner in the funds and assets of the Association cannot be assigned, pledged or transferred in any manner except as an appurtenance to a unit in the Condominium.

(c) Except as limited in these Bylaws, each co-owner shall be entitled to one vote for each unit owned when voting by number and one vote, the value of which shall equal the total of the percentages allocated to the units owned by such co-owner as set forth in the Master Deed, when voting by value. Voting shall be by number except in those instances when voting is specifically required to be both in value and in number or in value only. In the case of any unit owned jointly by more than one co-owner, the voting rights appurtenant to that unit may be exercised jointly as a single vote or may be split if all the joint co-owners of the unit so agree in writing.

(d) No co-owner, other than the Developer, shall be entitled to vote at any meeting of the Association until the co-owner has presented evidence of ownership of a unit in the Condominium to the Association. No co-owner, other than the Developer, shall be entitled to vote prior to the first annual meeting of members held in accordance with section 6 of this Article I except as specifically provided in section 7. The vote of each co-owner may only be cast by the individual representative designated by such co-owner in the notice required in subparagraph (e) below or by a proxy given by such individual representative.

(e) Each co-owner shall file a written notice with the Association designating the individual representative who shall vote at meetings of the Association and receive all notices and other communications from the Association on behalf of such co-owner. Such notice shall state the name and address of the individual representative designated, the number or numbers of the unit or units owned by the co-owner, and the name and address of each person, firm, corporation, partnership, association, trust or other entity who is the co-owner. Such notice shall be signed and dated by the co-owner. The individual representative designated may be changed by the co-owner at any time by filing a new notice in the manner herein provided. At any meeting the filing of such written notice as a prerequisite to voting may be waived by the chairman of the meeting.

(f) There shall be an annual meeting of the members of the Association commencing with the first annual meeting held as provided in section 6 of this Article I. Other meetings shall be held as provided for in the Corporate Bylaws of the Association. Notice of the time, place and subject matter of all meetings shall be given to each co-owner by mailing the same to each individual representative designated by the respective co-owners.

(g) The presence in person or by proxy of more than one-half in number of the co-owners shall constitute a quorum for holding a meeting of the members of the Association. The written vote of any person furnished at or prior to any duly called meeting at which meeting said person is not otherwise present in person or by proxy shall be counted in determining the presence of a quorum with respect to the question upon which the vote is cast.

(h) Votes may be cast in person or by proxy or in writing by a duly signed vote by the designated voting representative not present at a given meeting in person or by proxy. Proxies and any written votes must be filed with the Secretary of the Association at or before the appointed time of each meeting of the members of the Association. Cumulative voting shall not be permitted.

(i) Unless otherwise provided, any action which could be authorized at a meeting of the members shall be authorized by any affirmative vote of more than fifty (50%) percent. The foregoing statement and any other provision of the Master Deed, these Bylaws or the Corporate Bylaws requiring the approval of a majority (or other stated percentage) of the members or co-owners shall be construed to mean, unless otherwise specifically stated, a majority (or other stated percentage) in number (and not value) of the votes cast by those qualified to vote and present in person or by proxy (or written vote, if applicable) at a given meeting of the members of the Association duly called and held.

(j) Other provisions as to voting by members, not inconsistent with the provisions herein contained, may be set forth in the Corporate Bylaws.

Section 3. The Board of Directors of the Association shall keep detailed books of account showing all expenditures and receipts of the Condominium and its administration which shall specify the maintenance and repair expenses of the common elements and any other expenses incurred by or on behalf of the Association. All books, records and contracts of the Association shall be available for examination by any of the co-owners and their mortgagees during convenient times. All books and records shall be audited and reviewed at least annually by independent accountants; provided, however, that such audits need not be certified. The Association shall prepare and distribute to each co-owner at least annually a financial statement, the contents of which shall be defined by the Association. Any institutional holder of a first mortgage lien on any unit in the

Condominium shall be entitled to receive a copy of such annual audited financial statement within 90 days following the end of the Association's fiscal year upon request therefor. The costs of any such audit and any accounting expenses shall be expenses of administration. The Association shall keep current copies of the Master Deed establishing the Condominium and all amendments to the Master Deed and all other Condominium documents available for inspection at reasonable hours by co-owners, prospective purchasers of Condominium units and existing and prospective mortgagees of Condominium units.

Section 4. The affairs of the Association shall be governed by a Board of Directors, all of whom shall serve without compensation. Directors must be members of the Association, except for the First Board of Directors designated in the Articles of Incorporation of the Association and any successors thereto appointed prior to the first annual meeting of members held pursuant to section 6 of this Article I. If a member is a partner or corporation, then any partner or employee of the Partnership, or officer, director or employee of the Corporation shall be qualified to serve as a Director.

(a) The Board of Directors shall have all powers and duties necessary for the administration of the affairs of the Association and may do all acts and things necessary thereto subject to the provisions of the Master Deed, these Bylaws, the Corporate Bylaws, Articles of Incorporation and applicable laws. In addition to the foregoing general duties, the Board of Directors shall be responsible specifically for the following:

- (i) To manage and administer the affairs of and maintain the condominium and the common elements thereof.
- (ii) To collect assessments from the members of the Association and to use the proceeds thereof for the purpose of the Association.
- (iii) To carry insurance and collect and allocate the proceeds thereof.
- (iv) To rebuild improvements after casualty.
- (v) To contract for and employ persons, firms, corporations or other agents to assist in the management, operation, maintenance and administration of the Condominium project.
- (vi) To acquire, maintain and improve, and to buy, operate, manage, sell, convey, mortgage or lease any real or personal property (including Condominium units, easements, rights-of-way and licenses) on behalf of the Association in furtherance of any of the purposes of the Association, including (but without limitation) the lease or purchase of any unit in the Condominium for use by a resident manager. The purchase, sale, mortgage or lease of any real property (including any unit in the Condominium) shall require the approval of a majority of the members.
- (vii) To borrow money and issue evidences of indebtedness in furtherance of any and all of the purposes of the business of the Association. Prior to the first annual meeting of the co-owners, the Board of Directors may make such borrowing only with the approval of a majority of the members.
- (viii) To make rules and regulations in accordance with Article VI, section 10 of these Bylaws.

(fx) To establish such committees as it deems necessary, convenient or desirable and to appoint persons thereto for the purpose of implementing the administration of the Condominium and to delegate to such committees any functions or responsibilities.

(x) To make rules and regulations and to enter into agreements with institutional lenders the purposes of which are to obtain mortgage financing for unit co-owners which is acceptable for purchase by the Federal Home Loan Mortgage Corporation, the Federal National Mortgage Association, the Government National Mortgage Association and/or any governmental agency or to satisfy the requirements of the United States Department of Housing and Urban Development.

(xi) To enforce the provisions of the Master Deed, these Bylaws, the Corporate Bylaws and the Articles of Incorporation.

(b) The Board of Directors may employ for the Association a professional management agent (which may include the Developer or any person or entity affiliated with the Developer) at reasonable compensation established by the Board to perform such duties and services as the Board shall authorize, including, but not limited to, the duties listed in section 4(a) of this Article I, and the Board may delegate to such management agent any other duties or powers. In the event the Board does employ professional management for the Association, the Board shall secure the written approval of each institutional holder of a first mortgage lien on any unit in the Condominium prior to terminating professional management and assuming self-management. In no event may the Board enter into any contract for management, the maximum term of which is greater than three years. In addition to the foregoing, any contract for management or other services by and between the Association and the Developer or any affiliate of the Developer shall provide that such contract is voidable by the Board of Directors of the Association on the Transitional Control Date (as defined in the Master Deed) or within ninety (90) days thereafter, and on thirty (30) days' notice at any time thereafter for cause. To the extent any management contract extends beyond one (1) year after the transitional control date, the excess period under the contract may be voided by the Board of Directors of the Association by notice to the management agent at least thirty (30) days before the expiration of the one (1) year period.

(c) All of the actions (including, without limitation, the adoption of these Bylaws and any Rules and Regulations for the Association, any undertakings or contracts entered into with others on behalf of the Association) of the first Board of Directors of the Association named in its Articles of Incorporation or any successors thereto appointed before the first annual meeting of members shall be binding upon the Association in the same manner as though such actions had been authorized by a Board of Directors duly elected by the members of the Association at the first or any subsequent annual meeting of members, provided that such actions are consistent with the powers and duties of the Board of Directors described in these Bylaws, the Corporate Bylaws, the Master Deed, and any other document establishing the Condominium.

Section 5. The Corporate Bylaws shall provide for the designation, number, terms of office, qualifications, manner of election, duties, manner of removal and replacement of the officers of the Association and may contain any other provisions pertinent to officers of the Association. Officers may be compensated, but only upon the affirmative vote of more than sixty (60%) percent of the co-owners in number.

Section 6. The first annual meeting of the members of the Association may be convened only by the Developer and may be called, in the

Developer's discretion, at any time on or before the earlier of the dates provided for the first annual meeting in subsections 7(b) and 7(c) of this Article I. The date, time and place of such first annual meeting shall be set by the Board of Directors, and at least ten (10) days' written notice thereof shall be given to each co-owner. Thereafter, an annual meeting shall be held each year on such date as is specified in the Corporate Bylaws.

Section 7. The following provisions shall apply notwithstanding the fact that the first annual meeting may not have been called:

(a) An advisory committee of nondeveloper co-owners shall be established either one hundred twenty (120) days after conveyance of legal or equitable title to nondeveloper co-owners of one-third (1/3) of the units that may be created, or one (1) year after the initial conveyance of legal or equitable title to a nondeveloper co-owner of a unit in the project, whichever occurs first. The advisory committee shall meet with the condominium project board of directors for the purpose of facilitating communication and aiding the transition of control to the association of co-owners. The advisory committee shall cease to exist when a majority of the board of directors of the association of co-owners is elected by the nondeveloper co-owners.

(b) Not later than one hundred twenty (120) days after conveyance of legal or equitable title to nondeveloper co-owners of twenty-five (25%) percent of the units that may be created, at least one (1) director and not less than twenty-five (25%) percent of the board of directors of the association of co-owners shall be elected by nondeveloper co-owners. Not later than one hundred twenty (120) days after conveyance of legal or equitable title to nondeveloper co-owners of fifty (50%) percent of the units that may be created, not less than thirty-three and one-third (33-1/3%) percent of the board of directors shall be elected by nondeveloper co-owners. Not later than one hundred twenty (120) days after conveyance of legal or equitable title to nondeveloper co-owners of seventy-five (75%) percent of the units that may be created, and before conveyance of ninety (90%) percent of such units, the first annual meeting shall be called and the nondeveloper co-owners shall elect all directors on the board, except that the Developer shall have the right to designate at least one (1) director as long as the Developer owns and offers for sale at least ten (10%) percent of the units in the project or as long as ten (10%) percent of the units remain that may be created.

(c) Notwithstanding the formula provided in subsection (b), 54 months after the first conveyance of legal or equitable title to a nondeveloper co-owner of a unit in the project, if title to not less than seventy-five (75%) percent of the units that may be created has not been conveyed, the first annual meeting shall be called and the nondeveloper co-owners have the right to elect as provided in the condominium documents, a number of members of the board of directors of the association of co-owners equal to the percentage of units they hold, and the Developer has the right to elect as provided in the condominium documents, a number of members of the board equal to the percentage of units which are owned by the Developer and for which all assessments are payable by the Developer. This election may increase, but shall not reduce, the minimum election and designation rights otherwise established in subsection (b). Application of this subsection does not require a change in the size of the board as determined in the condominium documents.

(d) If the calculation of the percentage of members of the board that the nondeveloper co-owners have the right to elect under subsection (b), or if the product of the number of members of the board multiplied by the percentage of units held by the nondeveloper co-owners under subsection (c) results in a right of nondeveloper co-owners to elect a fractional



number of members of the board, then a fractional election right of 0.5 or greater shall be rounded up to the nearest whole number, which number shall be the number of members of the board that the nondeveloper co-owners have the right to elect. After application of this formula the Developer shall have the right to elect the remaining members of the board. Application of this subsection shall not eliminate the right of the Developer to designate one (1) member as provided in subsection (b).

(e) As used in this section, the term "units that may be created" means the maximum number of units in all phases of the Condominium as stated in the Master Deed.

Section 8. Any reference to the "first Board of Directors" in the Master Deed, these Bylaws, the Corporate Bylaws, or the Articles of Incorporation shall mean and refer to the Board of Directors named in the Articles of Incorporation, including any successor or additional director appointed by the first board of directors prior to the first annual meeting of the members of the Association.

ARTICLE II

Section 1. The Association shall be assessed as the person or entity in possession of any tangible personal property of the Condominium owned or possessed in common by the co-owners, and personal property taxes based thereon shall be treated as expenses of administration.

Section 2. Expenditures affecting administration of the Condominium shall include all costs incurred in satisfaction of any liability arising within, caused by or connected with the common elements or the administration of the Condominium. Receipts affecting administration of the Condominium shall include all sums received as proceeds of, or pursuant to, a policy of insurance securing the interests of the co-owners against liabilities or losses arising within, caused by or connected with the common elements or the administration of the Condominium.

Section 3. Assessments shall be determined in accordance with the following provisions:

(a) The Board of Directors of the Association shall establish an annual budget in advance for each fiscal year and such budget shall project all expenses for the forthcoming year which may be required for the proper operation, management and maintenance of the Condominium, including a reasonable allowance for contingencies and reserves. Upon adoption of an annual budget by the Board of Directors, copies of the budget shall be delivered to each co-owner and the assessment for the year shall be established based upon said budget. The Board of Directors of the Association may increase the assessment if the Board of Directors finds that the revenues of the Association are insufficient to pay costs of operation. Special assessments may be made by the Board of Directors from time to time for payment of any obligation of the Association. In any fiscal year of the Association, expenditures for capital improvements may not exceed Nine Hundred (\$900.00) Dollars or Fifty (\$50.00) Dollars per unit (whichever is greater), unless such expenditures are approved by sixty (60%) percent of the co-owners in number. The first Board of Directors shall not authorize any capital improvements at the expense of the Association. The Board of Directors shall maintain a reserve fund for major repairs and replacement of common elements, which reserve fund shall be in the amount of not less than ten (10%) percent of the Association's current annual budget (excluding that portion of the budget allocated to the reserve fund itself) on a noncumulative basis. The minimum standard required by this subsection may prove to be inadequate for the Condominium. The Board of Directors shall annually consider the needs of the Condominium

to determine if a greater amount should be set aside in reserve or if additional reserve funds should be established for any other purposes.

Section 4. All assessments levied against the co-owners to cover expenses of administration shall be apportioned among and paid by the co-owners, including the Developer to the extent of the occupied units owned by the Developer, subject to section (9) of this Article in accordance with the percentage of value allocated to each unit in the Master Deed and any other assessment provisions in the Master Deed. Assessments shall be payable by co-owners in twelve (12) equal monthly installments. The payment of an assessment shall be in default if such assessment, or any part thereof, is not paid to the Association in full on or before the due date for such payment. Assessments in default shall bear interest at the rate of seven (7%) percent per annum until paid in full. The Board of Directors may also adopt uniform late charges pursuant to section 10 of Article VI of these Bylaws. Each co-owner (whether one or more persons) shall be personally liable for the payment of all assessments levied against the unit. A co-owner selling a unit shall not be entitled to any refund whatsoever from the Association with respect to any reserve, account or other asset of the Association. Sums assessed to any reserve, which are unpaid constitute a lien upon the unit or units in the Condominium owned by the co-owner at the time of the assessment before other liens except tax liens on the Condominium unit in favor of any state or federal taxing authority and sums unpaid on the first mortgage of record, except that past due assessments which are evidenced by a notice of lien, recorded as provided hereafter in section 8 of this Article have priority over a first mortgage recorded subsequent to the recording of the notice of lien. The lien upon each Condominium unit owned by the co-owner shall be in the amount assessed against the Condominium unit, plus a proportionate share of the total of all other unpaid assessments attributable to condominium units no longer owned by the co-owner but which became due while the co-owner had title to the Condominium units. The lien may be foreclosed by an action or by advertisement by the Association in the name of the Condominium on behalf of the other co-owners.

Section 5. No co-owner shall be exempt from liability for contribution toward the expenses of administration by waiver of the use or enjoyment of any of the common elements or by the abandonment of a Condominium unit.

Section 6. The Association may enforce collection of delinquent assessments by a suit at law for a money judgment or by foreclosure of the statutory lien that secures payment of assessments. Each co-owner, and every other person who from time to time has any interest in the Condominium, shall be deemed to have granted to the Association the unqualified right to elect to foreclose such lien either by judicial action or by advertisement. The provisions of Michigan law pertaining to foreclosure of mortgages by judicial action and by advertisement, as the same may be amended from time to time, are incorporated herein by reference for the purposes of establishing the alternative procedures to be followed in lien foreclosure actions and the rights and obligations of the parties to such actions. Further, each co-owner and every other person who from time to time has any interest in the Condominium, shall be deemed to have authorized and empowered the Association to sell or to cause to be sold the unit with respect to which the assessment(s) is or are delinquent and to receive, hold and distribute the proceeds of such sale in accordance with the priorities established by Michigan law. The Association, acting on behalf of all co-owners, may bid in at the foreclosure sale, and acquire, hold, lease, mortgage, or convey the Condominium unit. The expenses incurred in collecting unpaid assessments, including interest, costs, actual attorneys' fees (not limited to statutory fees) and advances for taxes or other liens paid by the Association to protect its lien, plus any late charges, shall be chargeable to the co-owner in default and shall be

secured by the Lien on the unit. In the event of default by any co-owner in the payment of any installment of the annual assessment, the Association shall have the right to declare all unpaid installments of the annual assessment for the pertinent fiscal year immediately due and payable. The Association may also discontinue the furnishing of any utilities or other services to a co-owner in default upon seven (7) days' written notice to such co-owner of its intention to do so. A co-owner in default shall not be entitled to utilize any of the general common elements of the Condominium and shall not be entitled to vote at any meeting of the Association so long as such default continues. In a judicial foreclosure action, a receiver may be appointed to take possession of the unit if the unit is not occupied by the co-owner and to lease the Condominium unit and collect and apply the rental therefrom.

Section 7. Notwithstanding any other provisions of the Master Deed, these Bylaws, the Corporate Bylaws or Articles of Incorporation of the Association, if the mortgagee of a first mortgage of record or other purchaser of a Condominium unit obtains title to the Condominium unit as a result of foreclosure of the first mortgage, such person, its successors and assigns, is not liable for the assessments by the Association chargeable to the unit which became due prior to the acquisition of title to the unit by such person and the expiration of the period of redemption from such foreclosure. The unpaid assessments are deemed to be common expenses collectible from all of the Condominium unit owners including such persons, its successors and assigns.

Section 8. The Association may not commence proceedings to foreclose a lien for unpaid assessments without recording and serving a notice of lien in the following manner:

(a) The notice of lien shall set forth the legal description of the Condominium unit or units to which the lien attaches, the name of the co-owner of record thereof, the amount due the Association as of the date of the notice, exclusive of interest, costs, attorneys fees and future assessments.

(b) The notice of lien shall be in recordable form, executed by an authorized representative of the Association, and may contain such other information as the Association deems appropriate.

(c) The notice of lien shall be recorded in the office of the register of deeds in the county in which the Condominium is situated and shall be served upon the delinquent co-owner by first class mail, postage prepaid, addressed to the last known address of the co-owner at least ten (10) days in advance of the commencement of the foreclosure proceedings.

Section 9. Notwithstanding any other provisions of these by-laws to the contrary, the Developer shall not pay regular monthly assessments prior to the first annual meeting of the members of the Association but shall reimburse the Association for any direct maintenance expenses incurred by the Association in connection with units owned by Developer. After said first annual meeting, the Developer shall pay regular monthly assessments for units which are completed, but for units which are not completed shall only reimburse the Association for direct maintenance expenses incurred by the Association in connection with such units. For purposes of this section (9), a unit is deemed completed when a certificate of occupancy has been issued for it by local building authorities.

Section 10. Upon the sale or conveyance of a Condominium unit, all unpaid assessments against the Condominium unit shall be paid out of the sale price or by the purchaser in preference over any other assessments or charges of whatever nature except (a) amounts due the State of Michigan

or any subdivision thereof for taxes or special assessments due and unpaid on the unit and (b) payments due under first mortgages having priority thereto. A purchaser of a Condominium unit is entitled to a written statement from the Association setting forth the amount of unpaid assessments outstanding against the unit and the purchaser is not liable for any unpaid assessment in excess of the amount set forth in such written statement, nor shall the unit be subject to any lien for any amounts in excess of the amount set forth in the written statement. Any purchaser or grantee who fails to request a written statement from the Association as provided herein at least five days before the sale shall be liable for any unpaid assessments against the unit together with interest, costs and attorneys' fees incurred in connection with the collection thereof.

ARTICLE III

Section 1. Disputes, claims, or grievances arising out of or relating to the interpretation or the application of the Master Deed, these Bylaws, Corporate Bylaws, Articles of Incorporation of the Association, or any rule or regulation of the Association, or any disputes, claims or grievances arising among or between co-owners and the Association shall, upon the election and written consent of the parties to any such disputes, claims or grievances and written notice to the Association, be submitted to arbitration, and the parties thereto shall accept the arbitrator's decision as final and binding. The Commercial Arbitration Rules of the American Arbitration Association as amended and in effect from time to time hereafter shall be applicable to any such arbitration.

Section 2. No co-owner nor the Association shall be precluded from petitioning the courts to resolve any such disputes, claims or grievances.

Section 3. Election by co-owners or the Association to submit any such dispute, claim or grievance to arbitration shall preclude such parties from litigating such dispute, claim or grievances in the courts.

Section 4. Any civil action proposed by the Board of Directors on behalf of the Association, other than for the collection of delinquent assessments, shall be subject to prior approval of a majority of the co-owners. After the first annual meeting of the members of the Association, the foregoing percentage requirements shall be determined without regard to any units which may be owned by the Developer.

ARTICLE IV

Section 1. The Association shall carry fire and extended coverage, vandalism and malicious mischief and liability insurance, and workmen's compensation insurance, if applicable, pertinent to the ownership, use and maintenance of the common elements of the Condominium, and such other insurance as the Board of Directors deems advisable, and all such insurance shall be carried and administered in accordance with the following provisions:

(a) All such insurance shall be purchased by the Association for the benefit of the Association, and the co-owners and their mortgagees, as their interests may appear, and provision shall be made for the issuance of certificates of mortgagee endorsements to the mortgagees of co-owners. Unit owners may obtain additional insurance upon their units, at their own expense, in addition to the coverage carried by the Association. It shall be each co-owner's responsibility to obtain insurance coverage for personal property located within a unit or elsewhere in the Condominium and for personal liability for occurrences within a unit or upon limited common elements appurtenant to a unit and also for alternate living expense in event of fire, and the Association shall have absolutely no responsibility

for obtaining such coverages. The Association and all co-owners shall use their best efforts to see that all property and liability insurance carried by the Association or any co-owner shall contain appropriate provisions whereby the insurer waives its right of subrogation as to any claims against any co-owner or the Association.

(b) All common elements of the Condominium shall be insured against fire and other perils covered by a standard extended coverage endorsement, in an amount equal to the appropriate percentage of maximum insurable replacement value, excluding foundation and excavation costs, as determined annually by the Board of Directors of the Association. Such coverage shall also include interior walls within the Association. Such wires, conduits and ducts contained therein and shall further include all fixtures, equipment and trim within a unit which were furnished with the unit, or such replacements or such improvements made by a co-owner within the unit. Any other improvements made by a co-owner within a unit shall be covered by insurance obtained by and at the expense of said co-owner; provided that, if the Association elects to include such improvements under its insurance coverage, any additional premium cost to the Association attributable thereto may be assessed to and borne solely by said co-owner and collected as part of the assessments against said co-owner under Article II hereof.

(c) All premiums for insurance purchased by the Association pursuant to these Bylaws shall be expenses of administration.

(d) Proceeds of all insurance policies owned by the Association shall be received by the Association, held in a separate account and distributed to the Association, the co-owners and their mortgagees as their interests may appear; provided, however, whenever repair or reconstruction of the Condominium shall be required as provided in Article V of these Bylaws, the proceeds of any insurance received by the Association as a result of any loss requiring repair or reconstruction shall be applied for such repair or reconstruction, and in no event shall hazard insurance proceeds be used for any purpose other than for repair, replacement or reconstruction of the Condominium unless all of the institutional holders of first mortgages on units in the Condominium have given their prior written approval.

Section 2. Each co-owner, by ownership of a unit in the Condominium, shall be deemed to appoint the Association as the co-owner's true and lawful attorney-in-fact to act in connection with all matters concerning the maintenance of fire and extended coverage, vandalism and malicious mischief, liability insurance and workmen's compensation insurance, if applicable, pertinent to the Condominium, the co-owner's unit and the common elements appurtenant thereto with such insurer as may, from time to time, provide such insurance for the Condominium. Without limitation on the generality of the foregoing, the co-owner's unit attorney shall have full power and authority to purchase and maintain such insurance, to collect and remit premiums therefor, to collect proceeds and to distribute the same to the Association, the co-owners and respective mortgagees, as their interests may appear (subject always to the provisions of the Master Deed and these Bylaws), to execute releases of liability and to execute all documents and to do all things on behalf of such co-owner and the Condominium as shall be necessary or convenient to the accomplishment of the foregoing.

ARTICLE V

Section 1. If any part of the Condominium shall be partially or completely destroyed, the determination of whether or not it shall be reconstructed or repaired shall be made in the following manner:

(a) If the damaged property is a common element or a unit, the property shall be rebuilt or repaired if any unit in the Condominium is tenantable, unless it is determined by a unanimous vote of all of the co-owners in the Condominium that the Condominium shall be terminated, and each institutional holder of a first mortgage lien on any unit in the Condominium has given prior written approval of such termination.

(b) If the Condominium is so damaged that no unit is tenantable, and if each institutional holder of a first mortgage lien on any unit in the Condominium has given its prior written approval of the termination of the Condominium, the damaged property shall not be rebuilt and the Condominium shall be terminated, unless seventy-five (75%) percent or more of all co-owners in number agree to reconstruction by vote or in writing within ninety (90) days after the destruction. The seventy-five (75%) percent majority required by this subsection (b) shall be applied to all existing co-owners and shall not mean seventy-five (75%) percent of the co-owners attending a meeting.

Section 2. Any such reconstruction or repair shall be substantially in accordance with the Master Deed and the plans and specifications for the Condominium to a condition as comparable as possible to the condition existing prior to damage unless the co-owners shall unanimously decide otherwise.

Section 3. If the damage is only to a part of a unit which is the responsibility of a co-owner to maintain and repair, it shall be the responsibility of the co-owner to repair such damage in accordance with section 4 hereof. In all other cases, the responsibility for reconstruction and repair shall be that of the Association.

Section 4. Each co-owner shall be responsible for the reconstruction and repair of the interior of the co-owner's unit, including, but not limited to, floor coverings, wall coverings, window shades, draperies, interior walls (but not any common elements therein), interior trim, furniture, light fixtures and all appliances, whether freestanding or built-in. In the event damage to any of the foregoing, or to interior walls within a co-owner's unit or to pipes, wires, conduits, ducts or other common elements therein is covered by insurance held by the Association, then the reconstruction or repair shall be the responsibility of the Association in accordance with section 5 of this Article. If any other interior portion of a unit is covered by insurance held by the Association for the benefit of the co-owner, the co-owner shall be entitled to receive the proceeds of insurance relative thereto, and if there is a mortgagee endorsement, the proceeds shall be payable to the co-owner and the mortgagee jointly. In the event of substantial damage to or destruction of any unit or any part of the common elements, the Association promptly shall so notify each institutional holder of a first mortgage lien on any unit in the Condominium.

Section 5. The Association shall be responsible for the reconstruction and repair of the common elements (except as specifically otherwise provided in the Master Deed) and any incidental damage to a unit caused by such common elements or the reconstruction and repair thereof. Immediately after a casualty causing damage to property for which the Association has the responsibility of repair and reconstruction, the Association shall obtain reliable and detailed estimates of the cost to replace the damaged property in a condition as good as that existing before the damage. If the proceeds of insurance are not sufficient to defray the estimated costs of reconstruction or repair required to be performed by the Association, or if at any time during such reconstruction or repair, or upon completion of such reconstruction or repair, the funds for the repayment of the costs thereof are insufficient, assessments shall be made against all co-owners for the cost of reconstruction or repair of the

damaged property in sufficient amounts to provide funds to pay the estimated or actual cost of repair.

Section 6. The following provisions shall apply upon any taking by eminent domain of any part of the Condominium:

(a) If any portion of the common elements is taken by eminent domain, the award therefor shall be allocated to the co-owners in proportion to their respective undivided interests in the common elements. The Association acting through its Board of Directors, may negotiate on behalf of all co-owners for any taking of common elements and any negotiated settlement approved by more than two-thirds (2/3) of the co-owners based upon assigned voting rights shall be binding on all co-owners.

(b) If a Condominium unit is taken by eminent domain, the undivided interest in the common elements appertaining to the condominium unit shall thenceforth appertain to the remaining Condominium units, being allocated to them in proportion to their respective undivided interests in the common elements. The court shall enter a decree reflecting the reallocation of undivided interests produced thereby, and the award shall include, without limitation, just compensation to the co-owner of the Condominium unit taken for the co-owner's undivided interest in the common elements as well as for the Condominium unit.

(c) If portions of a Condominium unit are taken by eminent domain, the court shall determine the fair market value of the portions of the condominium unit not taken. The undivided interest of such Condominium unit in the common elements appertaining to the Condominium units shall be reduced in proportion to the diminution in the fair market value of the Condominium unit resulting from the taking. The portions of undivided interest in the common elements thereby divested from the co-owners of a Condominium unit shall be reallocated among the other Condominium units in the Condominium project in proportion to their respective undivided interests in the common elements. A Condominium unit partially taken shall receive the reallocation in proportion to its undivided interest in the common elements as reduced by the court under this subsection. The court shall enter a decree reflecting the reallocation of undivided interests produced thereby, and the award shall include just compensation to the co-owner of the condominium unit partially taken for that portion of the undivided interest in the common elements divested from the co-owner and not revested in the co-owner, as well as for that portion of the Condominium unit taken by eminent domain.

(d) If the taking of a portion of a Condominium unit makes it impractical to use the remaining portion of that Condominium unit for a lawful purpose permitted by the Condominium documents, then the entire undivided interest in the common elements appertaining to that Condominium unit shall thenceforth appertain to the remaining Condominium units, being allocated to them in proportion to their respective undivided interests in the common elements. The remaining portion of that Condominium unit shall thenceforth be a common element. The court shall enter an order reflecting the reallocation of undivided interests produced thereby, and the award shall include just compensation to the co-owner of the Condominium unit for the co-owner's entire undivided interest in the common elements and for the entire Condominium unit.

(e) Votes in the association of co-owners and liability for future expenses of administration appertaining to a Condominium unit taken or partially taken by eminent domain shall thenceforth appertain to the remaining Condominium units, being allocated to them in proportion to the relative voting strength in the association of co-owners. A Condominium unit partially taken shall receive a reallocation as though the voting

strength in the association of co-owners was reduced in proportion to the reduction in the undivided interests in the common elements.

(F) In the event the Condominium continues after a taking by eminent domain, then the remaining portion of the Condominium shall be re-surveyed and the Master Deed amended accordingly. Such amendment may be effected by an officer of the Association duly authorized by the Board of Directors without the necessity of execution or specific approval thereof by any co-owner, but only with the prior written approval of all holders of first mortgage liens on individual units in the Condominium.

(g) In the event any unit in the Condominium, or any portion thereof, or the common elements or any portion thereof, is made the subject matter of any condemnation or eminent domain proceeding or is otherwise sought to be acquired by a condemning authority, the Association promptly shall so notify each institutional holder of a first mortgage lien on any of the units in the Condominium.

Section 7. In the event any mortgage in the Condominium is held by the Federal Home Loan Mortgage Corporation ("FHLMC"), or in the event any mortgage is held by or insured by the United States Department of Housing and Urban Development ("HUD"), the Association shall give FHLMC and HUD written notice at such address as it may from time to time direct of any loss to or taking of the common elements of the Condominium, or any loss to or taking of any unit, or part thereof, if the loss or taking exceeds \$10,000 in amount.

Section 8. Nothing contained in the Master Deed, these Bylaws, the Corporate Bylaws, or Articles of Incorporation of the Association shall be construed to give a Condominium unit owner, or any other party, priority over any rights of first mortgagees of Condominium units pursuant to their mortgages in the case of a distribution to Condominium unit owners of insurance proceeds or condemnation awards for losses to or a taking of Condominium units and/or common elements.

#### ARTICLE VI

Section 1. No unit in the Condominium shall be used for other than residential purposes. Any co-owner, including the Developer, may rent, occupancy. No co-owner shall carry on any commercial activities anywhere on the premises of the Condominium.

Section 2. No co-owner shall make alterations in exterior appearance or make structural modifications to any unit (including interior walls through or in which there exist easements for support or utilities) or make changes in any of the common elements, limited or general, without the express written approval of the Board of Directors including but not limited to, exterior painting or the erection of antennas, lights, aerials, awnings, doors, shutters or other exterior attachments or modifications; nor shall any co-owner damage or make modifications or attachments; common element walls between units which in any way impair sound conditioning qualities of the walls. The Board of Directors may approve only such modifications as do not impair the soundness, safety, utility or appearance of the Condominium.

Section 3. No immoral, improper, unlawful or offensive activity shall be carried on in any unit or upon the common elements, limited or general; nor shall anything be done which may be or become an annoyance or nuisance to the co-owners of the Condominium, nor shall any unreasonably noisy activity be carried on in any unit or on the common elements. No co-owner shall do or permit anything to be done or to keep or permit to be



kept in the co-owners unit or on the common elements anything that will increase the rate of insurance on the Condominium without the written approval of the Board of Directors, and each co-owner shall pay to the Association the increased cost of insurance premiums resulting from any such activity or the maintenance of any such condition.

Section 4. Without the prior written consent of the Board of Directors, no animal or pet other than one cat or one dog shall be kept in the Condominium by any co-owner. Any pets kept in the Condominium shall have such care and restraint as not to be obnoxious on account of noise, odor or unsanitary conditions. No savage or dangerous animal shall be kept. No animal may be permitted to run loose upon the common elements, and any animal shall at all times be attended by a responsible person while on the common elements. Any person who causes or permits an animal to be brought or kept on the Condominium property shall indemnify and hold harmless the Association for any loss, damage or liability which the Association may sustain as a result of the presence of such animal on the Condominium property. The term "animal or pet" as used in this section shall not include small animals which are constantly caged such as small birds or fish. All pets must be registered with the Board of Directors of the Association. The Board of Directors may further adopt rules and regulations limiting the size and weight of pets.

Section 5. The common elements, limited or general, shall not be used for storage of supplies, materials, personal property or trash or refuse of any kind, except as provided in the Master Deed or in duly adopted rules and regulations of the Association. Trash receptacles shall be maintained in areas designated therefor at all times and shall not be permitted to remain elsewhere on the common elements except for such short periods of time as may be reasonably necessary to permit periodic collection of trash. The common elements shall not be used in any way for the drying, shaking, or airing of clothing or other fabrics. Automobiles may only be washed in areas approved by the Board of Directors. In general, no activity shall be carried on nor condition maintained by a co-owner, either in a unit or upon the common elements, which detracts from the appearance of the Condominium.

Section 6. Sidewalks, yards, landscaped areas, roads, parking areas, balconies, patios and porches shall not be obstructed in any way; nor shall they be used for purposes other than for which they are reasonably and obviously intended. No bicycles, vehicles, chairs or benches may be left unattended on or about the common elements. Use of recreational facilities, if any are installed in the Condominium, may be limited to such times and in such manner as the Board of Directors shall determine by duly adopted regulations.

Section 7. No house trailers, commercial vehicles, boat trailers, boats, camping vehicles, camping trailers, snowmobiles, snowmobile trailers or vehicles other than automobiles may be parked or stored upon the premises of the Condominium, unless parked in an area specifically designated therefor by the Board of Directors. Commercial vehicles and trucks shall not be parked in or about the Condominium without the approval of the Board of Directors, except while making deliveries or pickups in the normal course of business. The Board of Directors may allocate or assign parking spaces from time to time on an equitable basis.

Section 8. No co-owner shall use, or permit the use by any occupant, agent, employee, invitee, guest or member of his family of any firearms, air rifles, pellet guns, B-B guns, bows and arrows, sling shots, or other similar dangerous weapons, projectiles or devices anywhere on or about the Condominium.

Section 9. No signs or other advertising devices shall be displayed which are visible from the exterior of a unit or on the common elements, including "For Sale" signs, without written permission from the Board of Directors.

Section 10. Reasonable regulations consistent with all laws, the Master Deed, these Bylaws, the Corporate Bylaws and Articles of Incorporation of the Association concerning the use of the common elements or the rights and responsibilities of the co-owners and the Association with respect to the Condominium or the manner of operation of the Association and of the Condominium may be made and amended from time to time by the Board of Directors. Copies of all such regulations and amendments thereto shall be furnished to all co-owners or posted on a general common element. Any such regulation or amendment may be revoked at any time by the affirmative vote of a majority of the owners.

Section 11. The Association and its duly authorized agents shall have access to each unit and any limited common elements appurtenant thereto from time to time, during reasonable working hours, upon notice to the co-owner thereof, as may be necessary for the maintenance, repair or replacement of any of the common elements. The Association or its agent shall also have access to each unit and any limited common elements appurtenant thereto at all times without notice as may be necessary to make emergency repairs to prevent damage to the common elements or to another unit. It shall be the responsibility of each co-owner to provide the Association means of access to the co-owner's unit and any limited common elements appurtenant thereto during all periods of absence and in the event of the failure of such co-owner to provide means of access, the Association may gain access in such manner as may be reasonable under the circumstances and shall not be liable to such co-owner for any necessary damage to any unit or any limited common elements appurtenant thereto caused thereby or for repair or replacement of such damage.

Section 12. No co-owner shall perform any landscaping or plant any trees or shrubs or place any ornamental materials upon the common elements unless approved by the Board of Directors in writing or unless permitted by the master deed or the regulations of the Association.

Section 13. No unsightly condition shall be maintained upon any balcony, patio or porch and only furniture and equipment consistent with ordinary balcony, patio or porch use shall be permitted to remain there during seasons when the same are reasonably in use and no furniture or equipment of any kind shall be stored on balconies, patios or porches during seasons when the same are not reasonably in use.

Section 14. Each co-owner shall maintain the unit owned and any limited common elements appurtenant thereto for which the co-owner has maintenance responsibility in a safe, clean and sanitary condition. Each co-owner shall also use due care to avoid damaging any of the common elements including but not limited to the telephone, water, gas, plumbing, electrical or other utility conduits and systems and any other elements in any unit which are appurtenant to or which may effect any other unit. Each co-owner shall be responsible for damages or costs to the Association resulting from negligent damage to or misuse of any of the common elements by the co-owner or the co-owner's family, guests, agents or invitees, unless such damages or costs are covered by insurance carried by the Association in which case there shall be no such responsibility, unless reimbursement to the Association is excluded by virtue of a deductible provision, in which case the responsible co-owner shall bear the expense to the extent of the deductible amount. Any costs or damages to the Association may be assessed to and collected from the responsible co-owner in the manner provided in Article II hereof.

Section 15. None of the restrictions contained in this Article VI shall apply to the commercial activities or signs or billboards, if any, of the Developer during the construction and sales period as hereinafter defined, or of the Association in furtherance of its powers and purposes. For the purposes of this section, the construction and sales period shall be deemed to continue so long as Developer owns any unit which Developer offers for sale. Until all units in the entire planned Condominium are sold by Developer, Developer shall have the right to maintain a sales office, a business office, a construction office, model units, storage areas, reasonable parking incident to the foregoing and such access to, from and over the Condominium as may be reasonable to enable sale of the entire Condominium by Developer.

Section 16. Co-owners, including Developer, may rent any number of units at any time, without limitation as to the term of occupancy subject to the following:

(a) A co-owner, including the Developer, desiring to rent or lease a Condominium unit for a period of longer than thirty (30) consecutive days, shall disclose that fact in writing to the association of co-owners at least ten (10) days before presenting a lease form to a potential lessee, and at the same time, shall supply the association of co-owners with a copy of the exact lease form for its review for its compliance with the condominium documents. A Developer proposing to rent Condominium units before the transitional control date shall notify either the advisory committee or each co-owner in writing.

(b) Tenants or nonco-owner occupants shall comply with all of the conditions of the condominium documents of the Condominium project, and all leases and rental agreements shall so state.

(c) If the association of co-owners determines that the tenant or nonco-owner occupant failed to comply with the conditions of the condominium documents, the association of co-owners shall take the following action:

(i) The association of co-owners shall notify the co-owner by certified mail, advising of the alleged violation by the tenant. The co-owner shall have fifteen (15) days after receipt of the notice to investigate and correct the alleged breach by the tenant or advise the association of co-owners that a violation has not occurred.

(ii) If after fifteen (15) days the association of co-owners believes that the alleged breach is not cured or may be repeated, it may institute on its behalf or derivatively by the co-owners on behalf of the association of co-owners, if it is under the control of the Developer, an action for both eviction against the tenant or nonco-owner occupant and, simultaneously, for money damages against the co-owner and tenant or nonco-owner occupant for breach of the conditions of the condominium documents. The relief provided for in this section may hold both the tenant and the co-owner liable for any damages to the general common elements caused by the co-owner or tenant in connection with the condominium unit or condominium project.

(d) When a co-owner is in arrearage to the association of co-owners for assessments, the association of co-owners may give written notice of the arrearage to a tenant occupying a co-owner's condominium unit under a lease or rental agreement, and the tenant, after receiving the notice, shall deduct from rental payments due the co-owner the arrearage and future assessments as they fall due and pay them to the association of

co-owners. The deduction shall not constitute a breach of the rental agreement or lease by the tenant.

ARTICLE VII

Section 1. Any co-owner who mortgages a unit shall notify the Association of the name and address of the mortgagee, and the Association shall maintain such information in a book maintained solely for such information. The Association may, at the written request of the mortgagee of any unit, report any unpaid assessments due from the co-owner of such unit. The Association shall give to the holder of any first mortgage covering any unit in the Condominium written notification of any default in the performance of the obligations of the co-owner of such unit that is not cured within 60 days.

Section 2. The Association shall notify each mortgagee appearing in said book of the name of each company insuring the Condominium against fire, perils covered by extended coverage, and vandalism and malicious mischief and the amounts of such coverage.

Section 3. Upon request submitted to the Association, any institutional holder of a first mortgage lien on any unit in the Condominium shall be entitled to receive written notification of every meeting of the members of the Association and to designate a representative to attend such meeting.

ARTICLE VIII

Section 1. These Bylaws may be amended by the Association or by the Developer in the manner provided in the Master Deed. Any amendment to these Bylaws (but not the Corporate Bylaws) shall become effective upon recordation in the office of the register of deeds in the county in which the Condominium is located. A copy of each amendment to these Bylaws shall be made available to every member of the Association after adoption; provided, however, that any amendment that is adopted in accordance with this Article shall be binding upon all persons who have an interest in the Condominium irrespective of whether such persons actually receive a copy of the amendment. These Bylaws may not be amended in any manner to eliminate or conflict with any mandatory provision of the Act or any applicable law or any provision of the Master Deed; nor may they be amended to materially reduce or eliminate the rights of any first mortgagees without the consent of the mortgagees affected.

ARTICLE IX

The Association of co-owners and all present or future co-owners, tenants, future tenants, or any other persons acquiring an interest in or using the facilities of the Condominium in any manner are subject to and shall comply with the provisions of the Act, the Master Deed, these Bylaws, the Corporate Bylaws, the Articles of Incorporation of the Association and the rules and regulations of the Condominium. In the event such Master Deed, Bylaws or Articles of Incorporation conflict with the provisions of any statute, the Statute shall govern. In the event such Master Deed, Bylaws or Articles of Incorporation conflict with the provisions of the Corporate Bylaws conflicts with any provision of the Master Deed, the Master Deed shall govern. If any provision of the Corporate Bylaws conflicts with any provision of these Bylaws, these Bylaws shall govern.

ARTICLE X

As used in the Master Deed, these Bylaws, the Corporate Bylaws and Articles of Incorporation of the Association, the term "Developer" refers to the Developer named in the Master Deed and any successor

developer. Pronouns used herein shall be deemed interchangeable with all other pronouns, as the context of the provisions hereof may require.

#### ARTICLE XI

Section 1. Any default by a co-owner shall entitle the Association or another co-owner or co-owners to the following relief:

- (a) Failure to comply with any of the terms or provisions of the Master Deed, these Bylaws, the Corporate Bylaws, the Articles of Incorporation, or the regulations of the Association shall be grounds for relief, which may include without limitation an action to recover sums due for damages, injunctive relief, foreclosure of Lien (if default in payment of assessment) or any combination thereof, and such relief may be sought by the Association, or, if appropriate, by an aggrieved co-owner or co-owners.
- (b) In any proceeding arising because of an alleged default by any co-owner, the Association, if successful, shall be entitled to recover the costs of the proceeding and such reasonable attorneys' fees (not limited to statutory fees) as may be determined by the Court, but in no event shall any co-owner be entitled to recover such attorneys' fees.

Section 2. The failure of the Association or of any co-owner to enforce any right, provision, covenant or condition which may be granted by the Master Deed, these Bylaws, the Corporate Bylaws, the Articles of Incorporation or regulations of the Association shall not constitute a waiver of the right of the Association or of any such co-owner to enforce such right, provision, covenant or condition in the future. All rights, remedies and privileges granted to the Association or any co-owner or co-owners pursuant to any terms, provisions, covenants or conditions of the aforesaid Master Deed, Bylaws, Articles or regulations shall be deemed to be cumulative and the exercise of any one or more shall not be deemed to constitute an election of remedies, nor shall it preclude the party thus exercising the same from exercising such other and additional rights, remedies or privileges as may be available to such party at law or in equity.

Section 3. Every director and every officer of the Association shall be indemnified by the Association against all expenses and liabilities, including attorney fees, reasonably incurred by or imposed upon the director or officer in connection with any proceeding to which the director or officer may be a party, or may become involved, by reason of the director or officer being or having been a director or officer of the corporation, whether or not a director or officer at the time such expenses are incurred, except that this indemnification shall not apply to willful and wanton misconduct or acts of gross negligence. The foregoing indemnification shall be in addition to and not exclusive of all other rights to which such director or officer may be entitled. At least ten (10) days prior to payment of any indemnification which it has approved, the Board of Directors shall notify all co-owners. Such payment must be approved by a majority vote of the Board of Directors without the vote of the director seeking the indemnification. In the event there has been no judicial determination whether the conduct of the director seeking indemnification constituted willful or wanton misconduct or gross negligence, the Board of Directors may rely upon an opinion of counsel, which counsel may not be a member of the Association.

#### ARTICLE XII

In the event that any of the terms, provisions, or covenants of the Master Deed, these Bylaws, the Corporate Bylaws, the Articles of Incorporation or regulations of the Association are held to be partially or wholly invalid or unenforceable for any reason whatsoever, such holding

shall not affect, alter, modify or impair in any manner whatsoever any of the other terms, provisions or covenants of such master deed, bylaws or articles or the remaining portions of any terms, provisions or covenants held to be partially invalid or unenforceable.

ARTICLE XIII

If any mortgage upon all or any portion of the Condominium premises is owned, held or insured by the United States Department of Housing and Urban Development then any reference in these Bylaws to "mortgagee," "first mortgagee," or "institutional holder" of mortgages shall be construed to include said Department of Housing and Urban Development.

123045PA563

WAYNE COUNTY CONDOMINIUM  
SUBDIVISION PLAN NO. 190  
EXHIBIT B TO MASTER DEED OF

# CHARNWOOD

PLYMOUTH TOWNSHIP, WAYNE COUNTY,  
MICHIGAN.

A CONDOMINIUM.

DEVELOPER  
CHARNWOOD GROUP  
A MICHIGAN CO-PARTNERSHIP  
27830 ORCHARD LAKE ROAD  
SUITE 203  
FARMINGTON HILLS, MICHIGAN  
48018

SURVEYOR  
MICHAEL L. PRIEST  
MICHAEL L. PRIEST & ASSOCIATES, INC.  
12550 FARMINGTON ROAD  
LIVONIA, MICHIGAN.  
48150

## PROPERTY DESCRIPTION

A PORTION OF LOT 48, SUPERVISOR S  
PLYMOUTH PLAT NO. 3 OF HOLCOMB S  
ADDITION TO THE VILLAGE OF PLYMOUTH  
AND PART OF SECTION 23, TOWN 1 SOUTH,  
RANGE 8 EAST, PLYMOUTH TOWNSHIP, WAYNE  
COUNTY, MICHIGAN, AS RECORDED IN LIBER 66,  
PAGE 38 OF PLATS, WAYNE COUNTY RECORDS.  
DESCRIBED AS: BEGINNING AT A POINT ON THE  
SOUTH LINE OF SAID LOT 48 DISTANT  
5.89°36'20"E. 28.20 FEET FROM THE SOUTH—  
WEST CORNER OF SAID LOT 48; THENCE  
NORTHERLY AN ARC DISTANCE OF 151.48 FEET  
ALONG A CURVE CONCAVE TO THE EAST  
THROUGH A CENTRAL ANGLE OF 3°27'43"  
TO THE END OF SAID CURVE; THENCE  
N.13°01'20"W. 92.06 FEET TO THE NORTH LINE  
OF SAID LOT 48; THENCE S.89°35'20"E.  
383.32 FEET ALONG SAID NORTH LINE;  
THENCE S.00°06'45"E. 235.64 FEET TO THE  
SOUTH LINE OF SAID LOT 48; THENCE  
N.89°36'20"W. 324.47 FEET TO THE POINT  
OF BEGINNING, CONTAINING 1.92 ACRES OF LAND.

## INDEX SHEET

1. COVER SHEET
2. SURVEY PLAN
3. SITE PLAN
4. UTILITY PLAN
5. BUILDING 1 FOUNDATION & FIRST FLOOR PLAN
6. BUILDING 1 SECOND FLOOR, SECTION
7. BUILDING 2 FOUNDATION & FIRST FLOOR
8. BUILDING 2 SECOND FLOOR, SECTION

ATTENTION: COUNTY REGISTRAR OF DEEDS  
THE CONDOMINIUM SUBDIVISION PLAN NUMBER  
MUST BE ASSIGNED IN CONSECUTIVE SEQUENCE.  
WHEN A NUMBER HAS BEEN ASSIGNED TO THIS  
PROJECT, IT MUST BE PROPERLY SHOWN IN THE  
TITLE, SHEET 1, AND SUPERVISOR'S CERTIFI—  
CATE, SHEET 2.



Michael L. Priest

L122045PA564

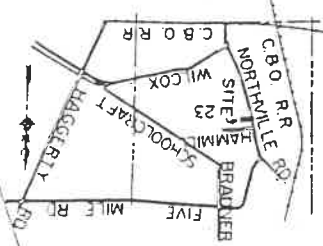

NORTHVILLE

ROAD

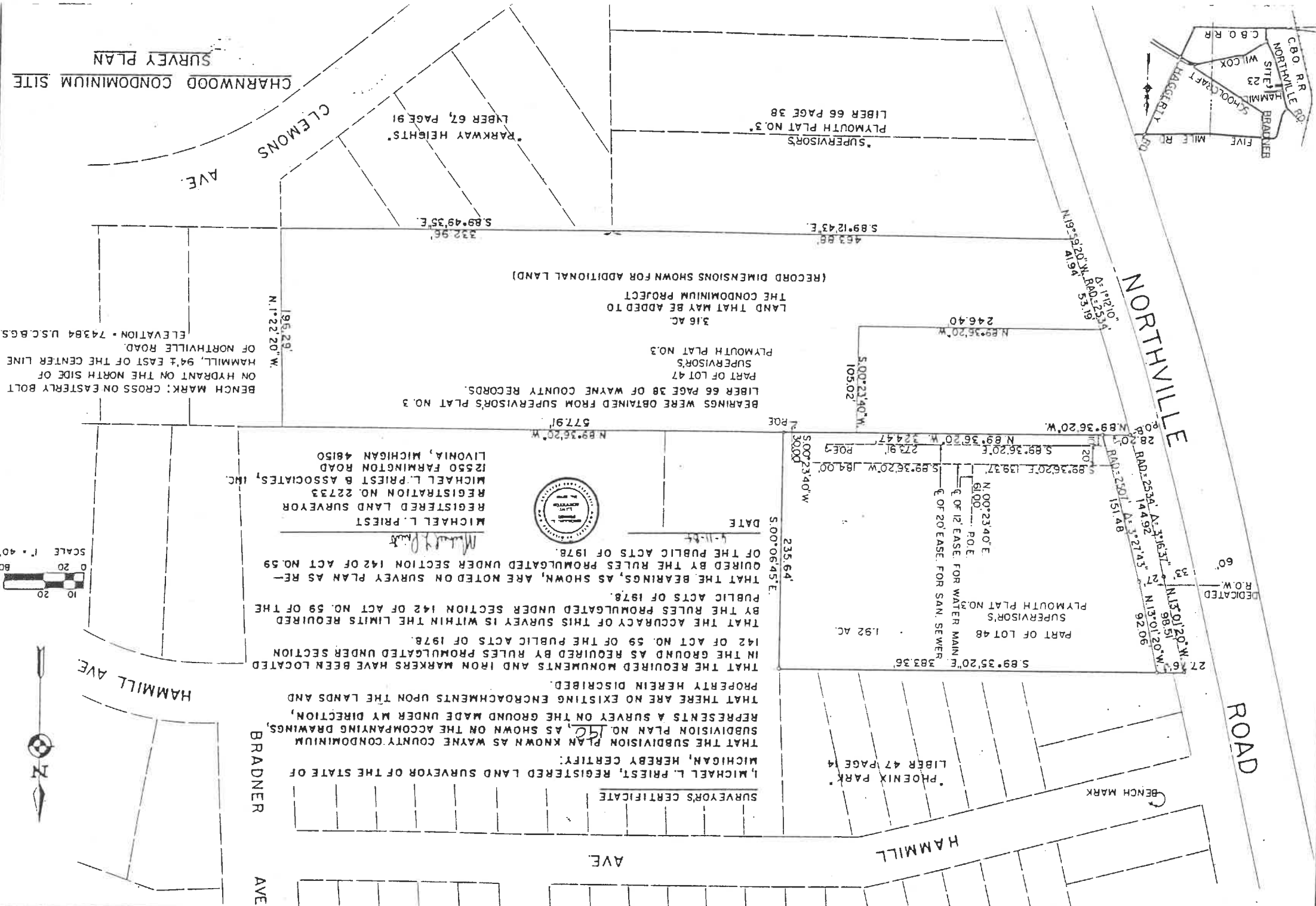

SURVEYOR'S CERTIFICATE  
I, MICHAEL L. PRIEST, REGISTERED LAND SURVEYOR OF THE STATE OF MICHIGAN, HEREBY CERTIFY:  
THAT THE SUBDIVISION PLAN KNOWN AS WAYNE COUNTY CONDOMINIUM SUBDIVISION PLAN NO. 150, AS SHOWN ON THE ACCOMPANYING DRAWINGS, REPRESENTS A SURVEY ON THE GROUND MADE UNDER MY DIRECTION, THAT THERE ARE NO EXISTING ENCROACHMENTS UPON THE LANDS AND PROPERTY HEREIN DESCRIBED.

THAT THE REQUIRED MONUMENTS AND IRON MARKERS HAVE BEEN LOCATED IN THE GROUND AS REQUIRED BY RULES PROMULGATED UNDER SECTION 142 OF ACT NO. 59 OF THE PUBLIC ACTS OF 1978.  
THAT THE ACCURACY OF THIS SURVEY IS WITHIN THE LIMITS REQUIRED BY THE RULES PROMULGATED UNDER SECTION 142 OF ACT NO. 59 OF THE PUBLIC ACTS OF 1978.  
THAT THE BEARINGS, AS SHOWN, ARE NOTED ON SURVEY PLAN AS REQUIRED BY THE RULES PROMULGATED UNDER SECTION 142 OF ACT NO. 59 OF THE PUBLIC ACTS OF 1978.

MICHAEL L. PRIEST  
REGISTERED LAND SURVEYOR  
REGISTRATION NO. 22733  
MICHAEL L. PRIEST & ASSOCIATES, INC.  
12550 FARMINGTON ROAD  
LIVONIA, MICHIGAN 48150

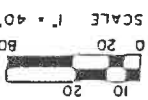

SCALE 1" = 40'

BENCH MARK: CROSS ON EASTERLY BOLT ON HYDRANT ON THE NORTH SIDE OF HAMMILL, 94'± EAST OF THE CENTER LINE OF NORTHVILLE ROAD.  
ELEVATION = 743.84 U.S.C.B.G.S.

CHARWOOD CONDOMINIUM SITE  
SURVEY PLAN



L22015PA565

CHARWOOD CONDOMINIUM  
SITE PLAN

MICHAEL L. PRIEST  
REGISTERED LAND SURVEYOR  
MICHAEL L. PRIEST & ASSOCIATES, INC.  
12550 FARMINGTON ROAD  
LIVONIA, MICHIGAN 48150

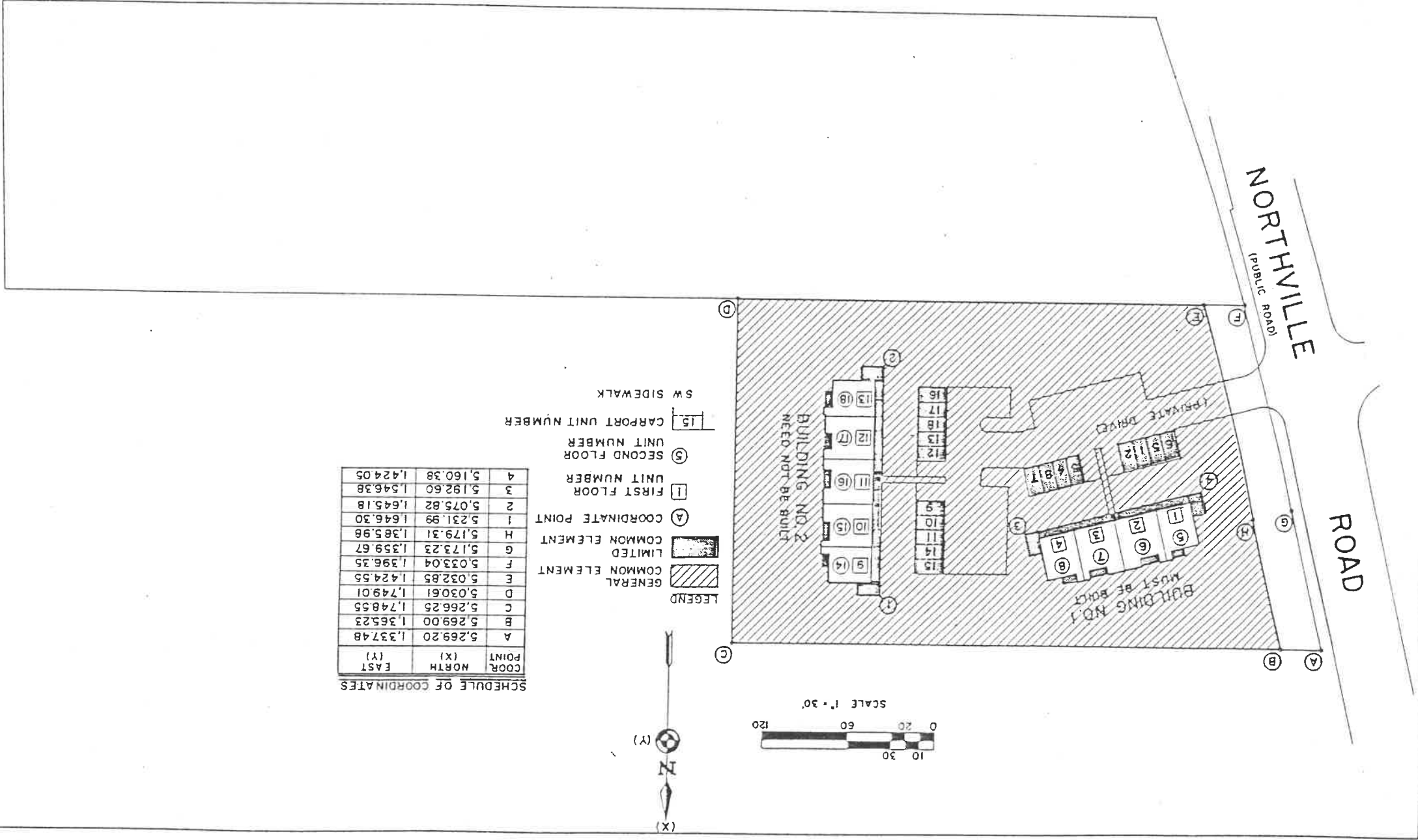

SCHEDULE OF COORDINATES

COORD. POINT	EAST (X)	NORTH (Y)
A	5,269.20	1,337.48
B	5,269.00	1,365.23
C	5,266.25	1,748.55
D	5,030.61	1,749.01
E	5,032.85	1,424.55
F	5,033.04	1,396.35
G	5,173.23	1,359.67
H	5,179.31	1,385.98
I	5,231.99	1,646.30
J	5,075.82	1,645.18
K	5,192.60	1,546.38
L	5,160.38	1,424.05

- LEGEND
- ▨ GENERAL COMMON ELEMENT
  - ▩ LIMITED COMMON ELEMENT
  - A COORDINATE POINT
  - I FIRST FLOOR UNIT NUMBER
  - S SECOND FLOOR UNIT NUMBER
  - ▭ 15 CARPORT UNIT NUMBER
  - SW SIDEWALK

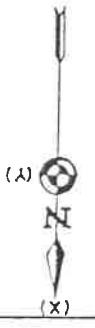
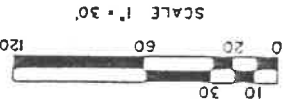

L1220 15PA566

ROAD

NORTHVILLE

PUBLIC

18" SAN.

18" ST.

12" WM

4" GAS

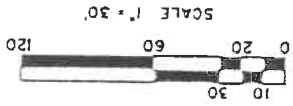
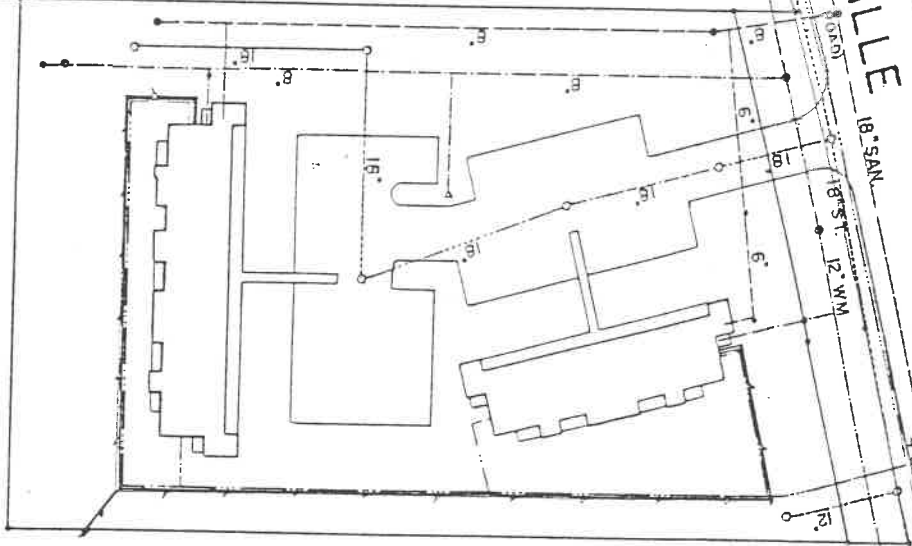

- LEGEND**
- STORM SEWER
  - SANITARY SEWER
  - WATER MAIN
  - GAS LINE
  - +—+— ELECTRIC & TELEPHONE LINES
  - +—+— UTILITIES POLE

NOTE: UTILITY METER LOCATIONS ARE SHOWN ON FLOOR PLANS SHEETS 5 & 7 ALL OF THE IMPROVEMENTS SHOWN HEREON NEED NOT BE BUILT.

LAND THAT MAY BE ADDED TO THE CONDOMINIUM PROJECT

CHARWOOD CONDOMINIUM  
UTILITIES PLAN



MICHAEL L. PRIEST  
REGISTERED LAND SURVEYOR  
MICHAEL L. PRIEST & ASSOCIATES INC  
12550 FARMINGTON ROAD  
LIVONIA, MICHIGAN 48150

*Michael L. Priest*

1220157A567

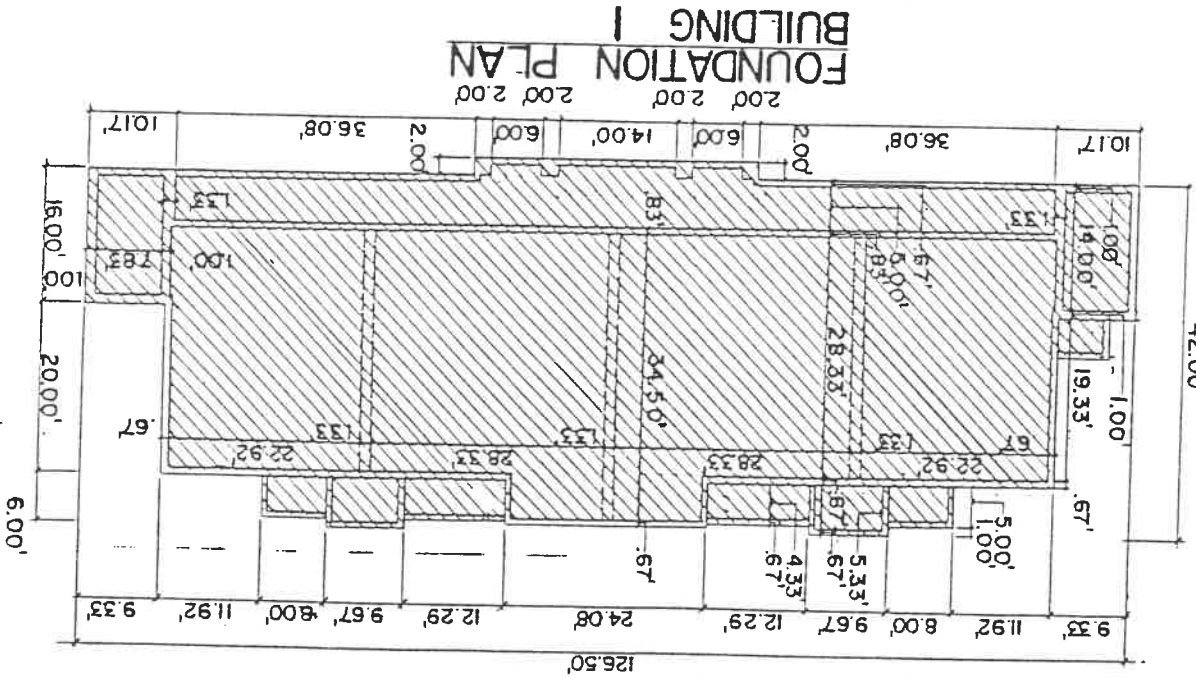
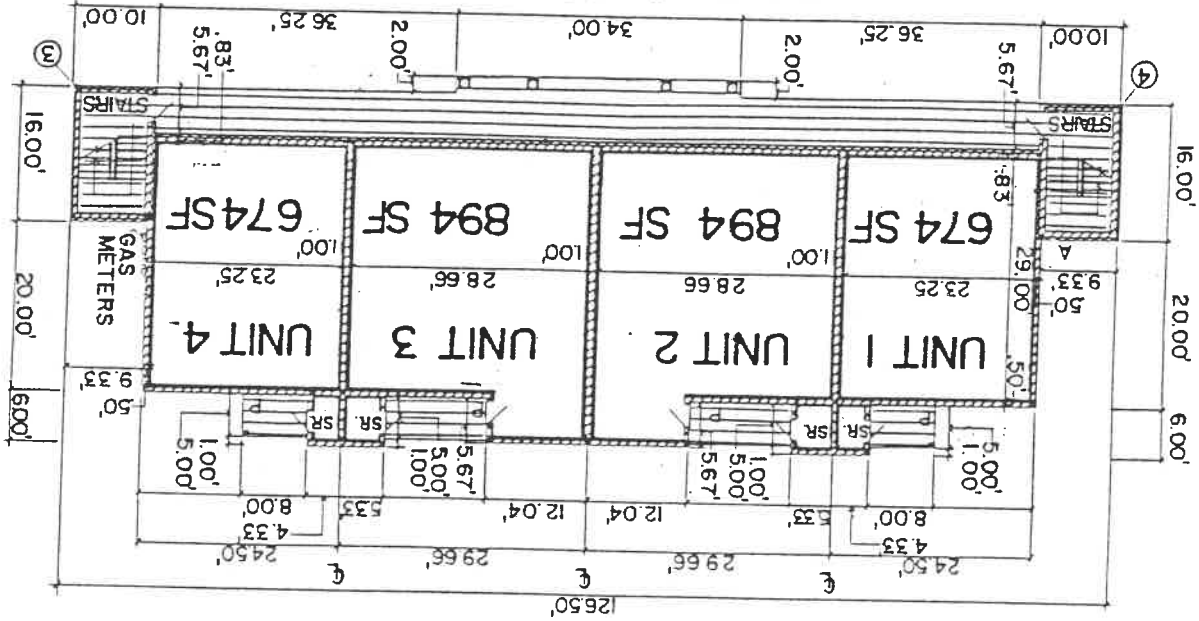
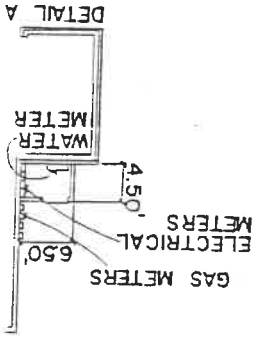

BUILDING 1  
FIRST FLOOR PLAN  
CHARWOOD CONDOMINIUM  
BUILDING 1  
"MUST BE BUILT"

MICHAEL L. PRIEST  
REGISTERED LAND SURVEYOR  
MICHAEL L. PRIEST & ASSOCIATES INC.  
12550 FARMINGTON ROAD  
LIVONIA, MICHIGAN 48150

Michael L. Priest

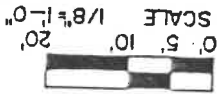

- LEGEND**
- GENERAL COMMON ELEMENT
  - LIMITED COMMON ELEMENT
  - LIMITS OF OWNERSHIP
  - STORAGE ROOM
  - PATIO-LIMITED COMMON ELEMENT
  - AREA IN SQUARE FEET DOES NOT INCLUDE STORAGE ROOM

CHARWOOD CONDOMINIUM

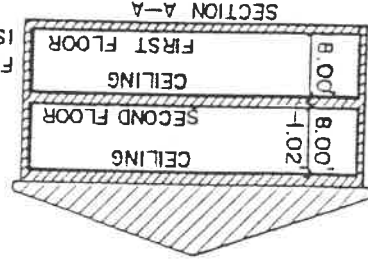

BUILDING I  
SECOND FLOOR PLAN

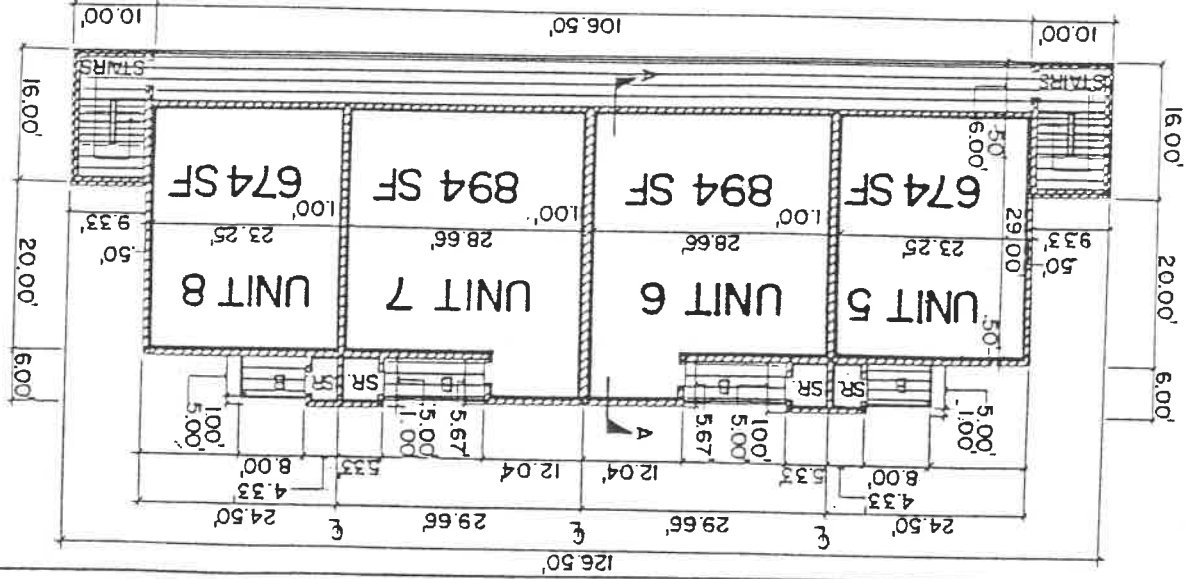

- LEGEND**
- GENERAL COMMON ELEMENT
  - LIMITED COMMON ELEMENT
  - LIMITS OF OWNERSHIP
  - S.R. STORAGE ROOM
  - B. BALCONY—LIMITED COMMON ELEMENT
  - S.F. AREA IN SQUARE FEET DOES NOT INCLUDE ANGLES
  - ALL WALLS AT RIGHT
  - STORAGE ROOM

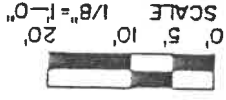

*Michael L. Priest*

MICHAEL L. PRIEST  
REGISTERED LAND SURVEYOR  
MICHAEL L. PRIEST & ASSOCIATES INC.  
12550 FARMINGTON ROAD  
LIVONIA, MICHIGAN 48150

122045PA569

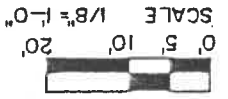
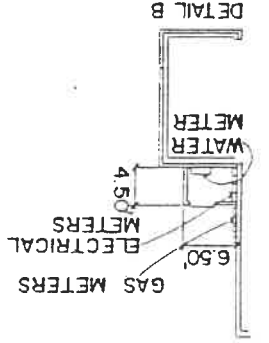
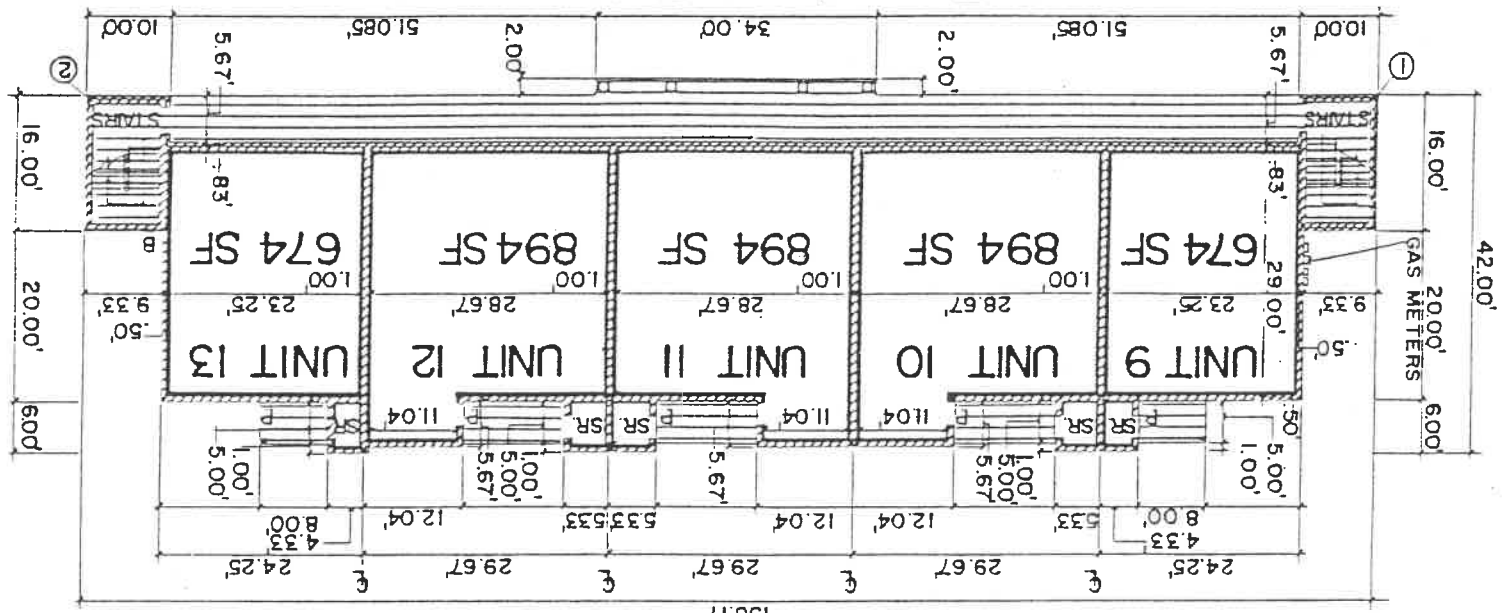
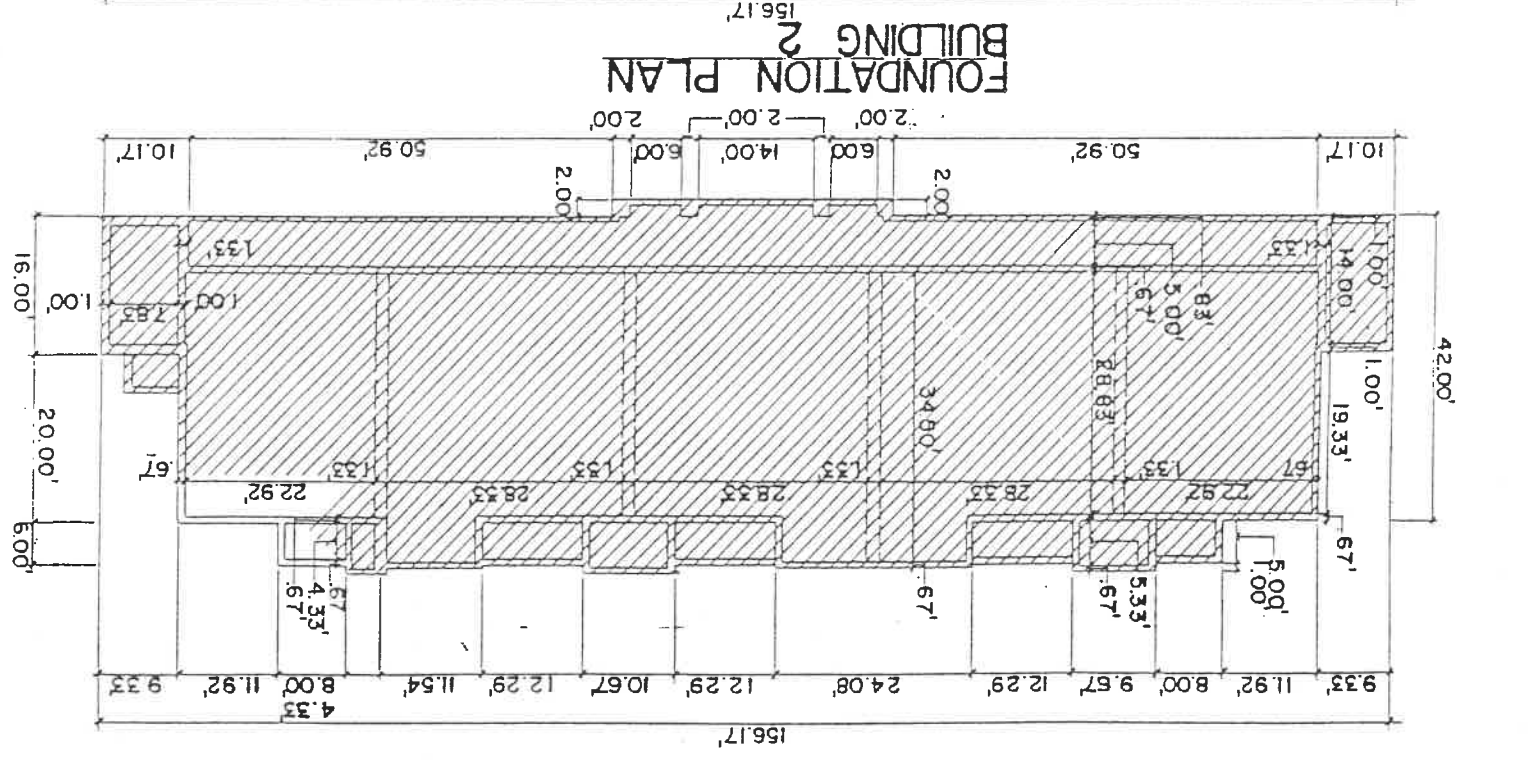

*Michael L. Priest*

MICHAEL L. PRIEST  
 REGISTERED LAND SURVEYOR  
 MICHAEL L. PRIEST & ASSOCIATES INC.  
 12550 FARMINGTON ROAD  
 LIVONIA, MICHIGAN 48150

CHARNWOOD CONDOMINIUM

BUILDING 2  
 FIRST FLOOR PLAN

"NEED NOT BE PLUM"

**SECOND FLOOR PLAN**  
**BUILDING 2**

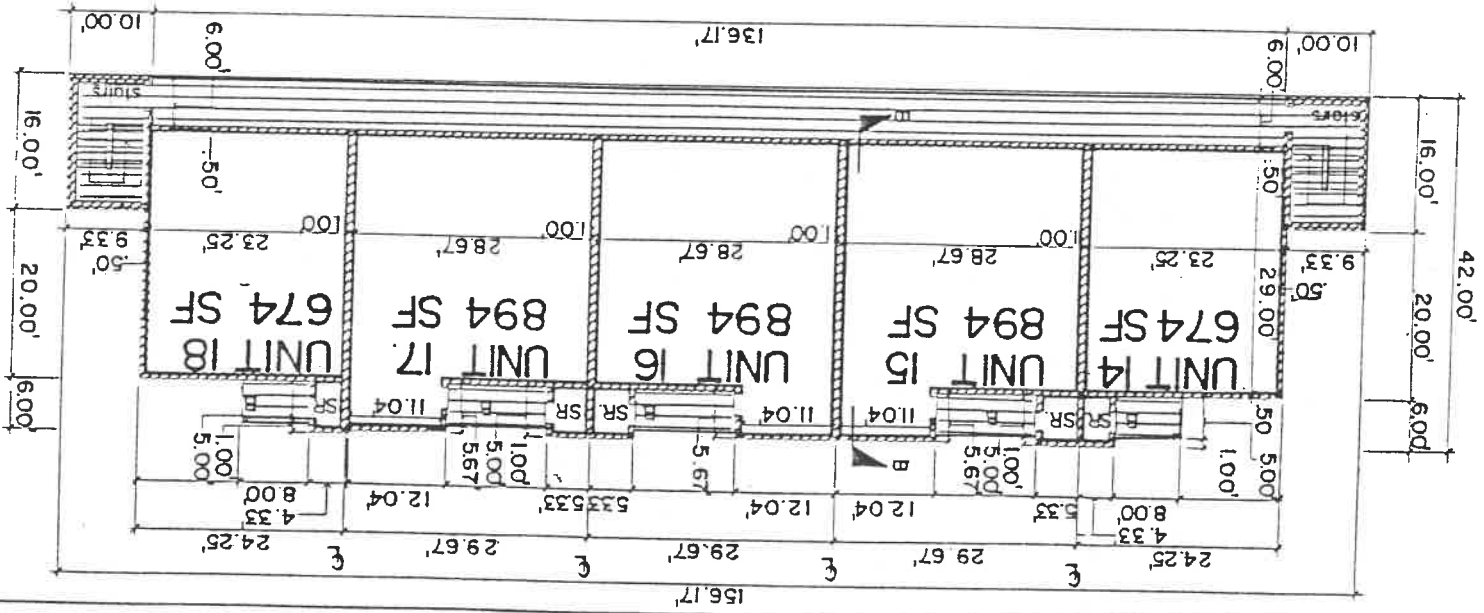

- LEGEND**
- GENERAL COMMON ELEMENT
  - LIMITED COMMON ELEMENT
  - LIMITS OF OWNERSHIP
  - SR STORAGE ROOM
  - B BALCONY - LIMITED COMMON ELEMENT
  - ALL WALLS AT RIGHT ANGLES
  - SF AREA IN SQUARE FEET DOES NOT INCLUDE STORAGE ROOM

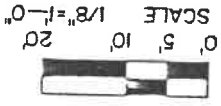

Michael L. Priest

MICHAEL L. PRIEST  
REGISTERED LAND SURVEYOR  
MICHAEL L. PRIEST & ASSOCIATES INC.  
12550 FARMINGTON ROAD  
LIVONIA, MICHIGAN 48150

CHARWOOD CONDOMINIUM

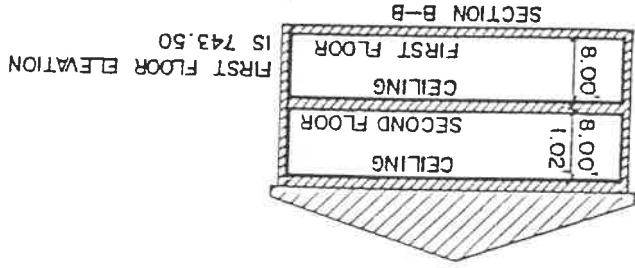

EXHIBIT C TO MASTER DEED  
CHARWOOD CONDOMINIUM

112201571

DESCRIPTION OF ADDITIONAL LAND

DESCRIPTION OF PROPOSED (NEED NOT BE BUILT) CHARWOOD CONDOMINIUM (PHASE II):

A portion of Lot 47, Supervisor's Plymouth Plat No. 3 of Holcomb's Addition to the Village of Plymouth and part of Section 23, T1S, R8E, Plymouth Township, Wayne County, Michigan, as recorded in Liber 66, Page 38 of Plats, Wayne County Records.

Described as: Beginning at NW Corner of Lot 46 thence S. 89°12'43" E. 463.88 feet; thence S. 89°49'35" E. 322.96 feet; thence N. 1°41'55" W. 196.29 feet; thence N. 89°36'20" W. 577.91 feet; thence S. 0°23'40" E. 105.02 feet; thence N. 89°36'20" W. 246.40 feet; thence S81°53.19 feet; thence S. 19°59'20" E. 41.94 feet to point of beginning.

LI22112PA874

FIRST AMENDMENT TO MASTER DEED OF  
CHARNWOOD

Charnwood Group, a Michigan Co-Partnership, being the Developer of Charnwood, a condominium project established pursuant to the Master Deed thereof, recorded on June 18, 1984, in Liber 22045, Pages 553-571, Wayne County Records, and known as Wayne County Subdivision Plan No. 190 hereby amend the Master Deed of Charnwood pursuant to the authority reserved in Article IX of the Master Deed regarding the relocation of the storm sewer line and the granting of an easement. Upon the recordation in the Office of the Wayne County Register of Deeds of this Amendment, the Master Deed and Exhibit B shall be amended in the following manner:



1. The following shall be added to Article VII.

Developer, its successors or assigns, grants a permanent easement and right-of-way, to the owners, their successors or assigns, of lots 66 and 67 of Phoenix Park Subdivision, a subdivision of part of the SE ¼ of the NW ¼ of Section 23, T1S, R8E, Plymouth Township, Wayne County, Michigan, as recorded in Liber 47, Page 14 of Plats, Wayne County Records, the right to enter upon the land for the purpose of connecting onto storm sewer structure No. 3.

2. Amended sheet No. 4 of Exhibit B, Condominium Subdivision Plan of Charnwood as attached hereto shall replace and supercede sheet No. 4 of Exhibit B, Condominium Subdivision Plan of Charnwood as originally recorded and the originally recorded Sheet No. 4 shall be of no further force or effect.

In all respects, other than as hereinabove indicated, the original Master Deed of Charnwood, including the Bylaws and Condominium Subdivision Plan respectively attached thereto as Exhibits A and B, recorded as aforesaid, is hereby ratified.

WITNESSES:

  
Leslie A. Rebtroy  
  
Kimberlee A. Schalk

CHARNWOOD GROUP  
A Michigan Co-Partnership  
By:   
Arthur A. Savoie  
Its: Partner

STATE OF MICHIGAN )  
                          ) SS.  
COUNTY OF OAKLAND)

The foregoing instrument was acknowledged before me this 16th day of August, 1984, by Arthur A. Savoie who is a Partner of Charnwood Group, a Michigan Co-Partnership, on behalf of the Co-Partnership.

  
Leslie A. Rebtroy

Notary Public, Oakland County, MI  
My Commission Expires **LESLIE A. REBTOY**  
Notary Public, Oakland County, MI  
My Commission Expires Oct. 4, 1985

DRAFTED BY AND WHEN RECORDED, PLEASE RETURN TO:  
Arthur A. Savoie  
Charnwood Group  
27830 Orchard Lake Road, Suite #203  
Farmington Hills, Michigan 48018



L122112, 875

REVISED 8-3-84 MOVED 18" STORM

# CHARWOOD CONDOMINIUM UTILITIES PLAN



MICHAEL L. PRIEST  
REGISTERED LAND SURVEYOR  
MICHAEL L. PRIEST & ASSOCIATES INC.  
12550 FARMINGTON ROAD  
LIVONIA, MICHIGAN 48150

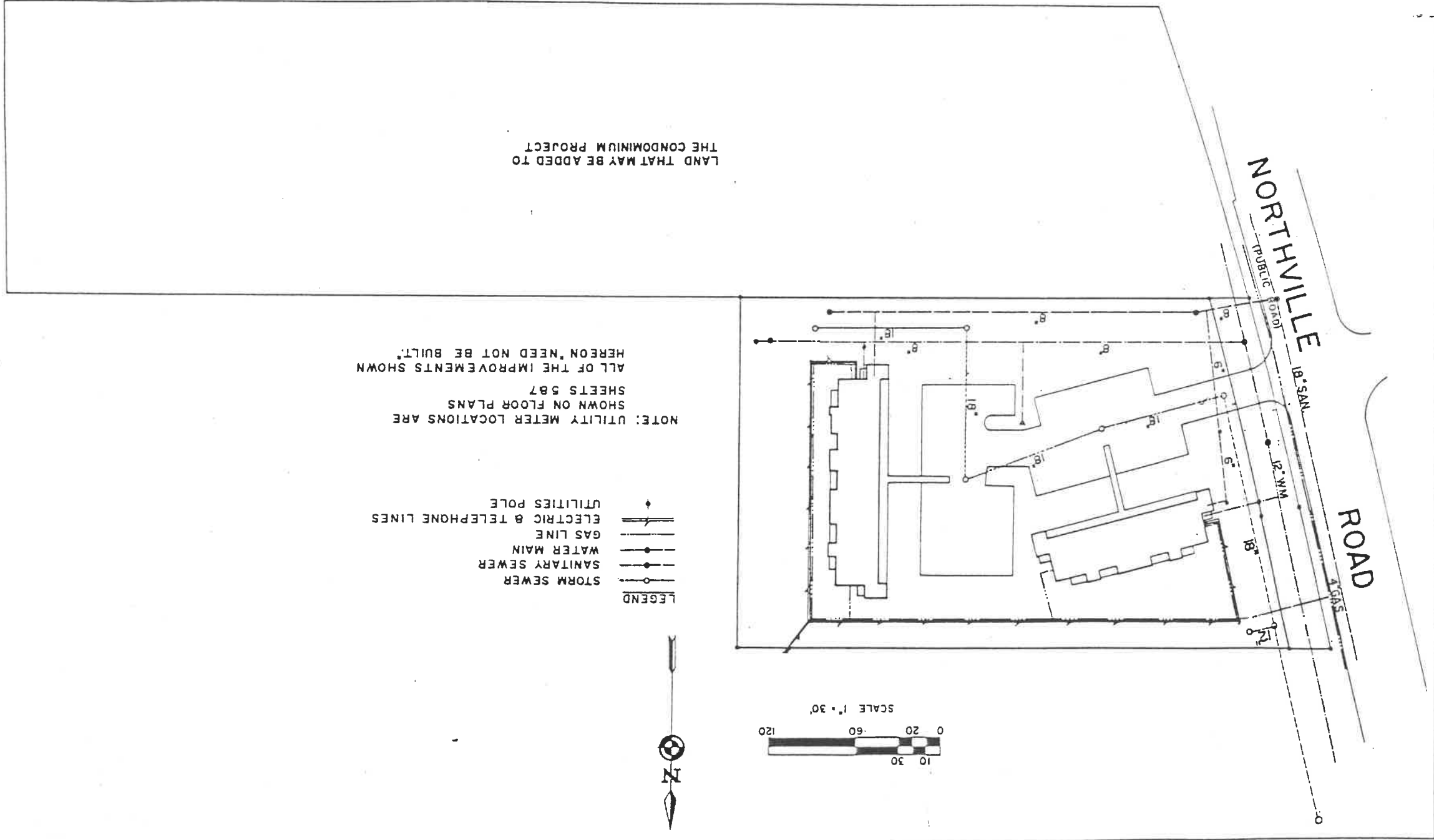

NOTE: UTILITY METER LOCATIONS ARE  
SHOWN ON FLOOR PLANS  
SHEETS 5&7  
ALL OF THE IMPROVEMENTS SHOWN  
HEREON NEED NOT BE BUILT.

LAND THAT MAY BE ADDED TO  
THE CONDOMINIUM PROJECT

- LEGEND
- STORM SEWER
  - SANITARY SEWER
  - WATER MAIN
  - GAS LINE
  - /— ELECTRIC & TELEPHONE LINES
  - ◆ UTILITIES POLE

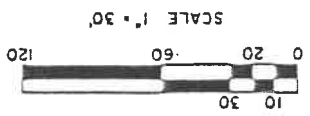

SECOND AMENDMENT TO MASTER DEED  
OF CHARNWOOD

CHARNWOOD GROUP, a Michigan Co-Partnership, being the Developer of Charnwood, a condominium project established pursuant to the Master Deed thereof, recorded on June 18, 1984, in Liber 22045, Pages 553-571, as amended by the First Amendment to Master Deed of Charnwood recorded on August 17, 1984, in Liber 22112, Pages 874 and 875, Wayne County Records, and known as Wayne County Condominium Subdivision Plan No. 190, hereby amends the Master Deed of Charnwood pursuant to the authority reserved in Article VIII of the Master Deed for the purpose of enlarging the Condominium Project from 8 units to 18 units by the addition of the building described as need not be built and reallocating the percentages of value set forth in Article VI of the Master Deed. Upon the recordation in the Office of the Wayne County Register of Deeds of this Amendment in the Deed and Exhibit B shall be amended in the following manner:

1. Article VI of the Master Deed of Charnwood as set forth below, shall replace and supersede Article VI of the Master Deed as recorded, and Article VI as originally recorded shall be of no further force or effect.

AMENDED ARTICLE VI OF MASTER DEED

CONDOMINIUM UNIT DESCRIPTION AND PERCENTAGE OF VALUE

G893167

A. The Condominium consists of eighteen (18) units. Each condominium unit is described in this paragraph with reference to the Condominium Subdivision Plan attached hereto as Exhibit B. Each Condominium unit shall include all that space contained within the interior side of the finished, unpainted perimeter walls, and within the ceilings and finished subfloor, all as shown on Exhibit B and delineated with heavy outlines. For all purposes, individual units may hereafter be defined and described by reference to this Master Deed and the individual number assigned to the unit in the Condominium Subdivision Plan.

B. The percentage of value assigned to each unit is set forth in this Article and shall be determinative of the proportionate share of each respective co-owner in the proceeds and expenses of the administration (except as provided in Article IV (c) above) and the value of such co-owner's vote at meetings of the Association and the undivided interest of the co-owner in the common elements. The total percentage value of the Condominium is 100%. Individual unit percentages of value shall be as follows:

<u>Schedule of Percentages of Value</u>	
<u>Unit Numbers</u> <u>According to Plan</u>	<u>Percentage</u> <u>For Each Unit</u>
1	4.7025
2	6.238
3	6.238
4	4.7025
5	4.7025
6	6.238
7	6.238
8	4.7025
9	4.7025
10	6.238
11	6.238
12	6.238
13	4.7025
14	4.7025
15	6.238
16	6.238
17	6.238
18	4.7025

RECORDED JAN 9 1985  
FOREST E. YOUNGBLOOD, Register of Deeds  
WAYNE COUNTY, MICHIGAN 48226

1105  
DRAWN 9

2. Amended sheets 3, and 7 of the Condominium Subdivision Plan of Charnwood as attached hereto shall replace and supersede Sheets 3 and 7 of the Condominium Subdivision Plan of Charnwood as originally recorded and the originally recorded sheets 3 and 7 shall be of no further force or effect.

In all respects, other than as hereinabove indicated, the original Master Deed of Charnwood, including the Bylaws and Condominium Subdivision Plan respectively attached thereto as Exhibits A and B, recorded as aforesaid, is hereby ratified.

WITNESSES:

CHARWOOD GROUP  
A Michigan Co-Partnership  
By: Arthur A. Savoie  
Arthur A. Savoie

Leslie A. Rebtov  
Leslie A. Rebtov  
Kimberlee A. Schalk  
Kimberlee A. Schalk

Its: Partner

STATE OF MICHIGAN )  
                                  ) SS.  
COUNTY OF OAKLAND)

The foregoing instrument was acknowledged before me this 7 day of January, 19 85, by Arthur A. Savoie who is a Partner of Charnwood Group, a Michigan Co-Partnership, on behalf of the Co-Partnership.

Leslie A. Rebtov  
Leslie A. Rebtov

Notary Public, Oakland County, MI  
My Commission Expires **LESLIE A. REBTOY**  
Notary Public, Oakland County, MI  
My Commission Expires Oct. 4, 1987

DRAFTED BY AND WHEN RECORDED, PLEASE RETURN TO:

Arthur A. Savoie  
Charnwood Group  
27830 Orchard Lake Road, Suite #203  
Farmington Hills, Michigan 48018

CHARWOOD CONDOMINIUM  
SITE PLAN

MICHAEL L. PRIEST  
REGISTERED LAND SURVEYOR  
MICHAEL L. PRIEST & ASSOCIATES INC.  
12550 FARMINGTON ROAD  
LIVONIA, MICHIGAN 48150

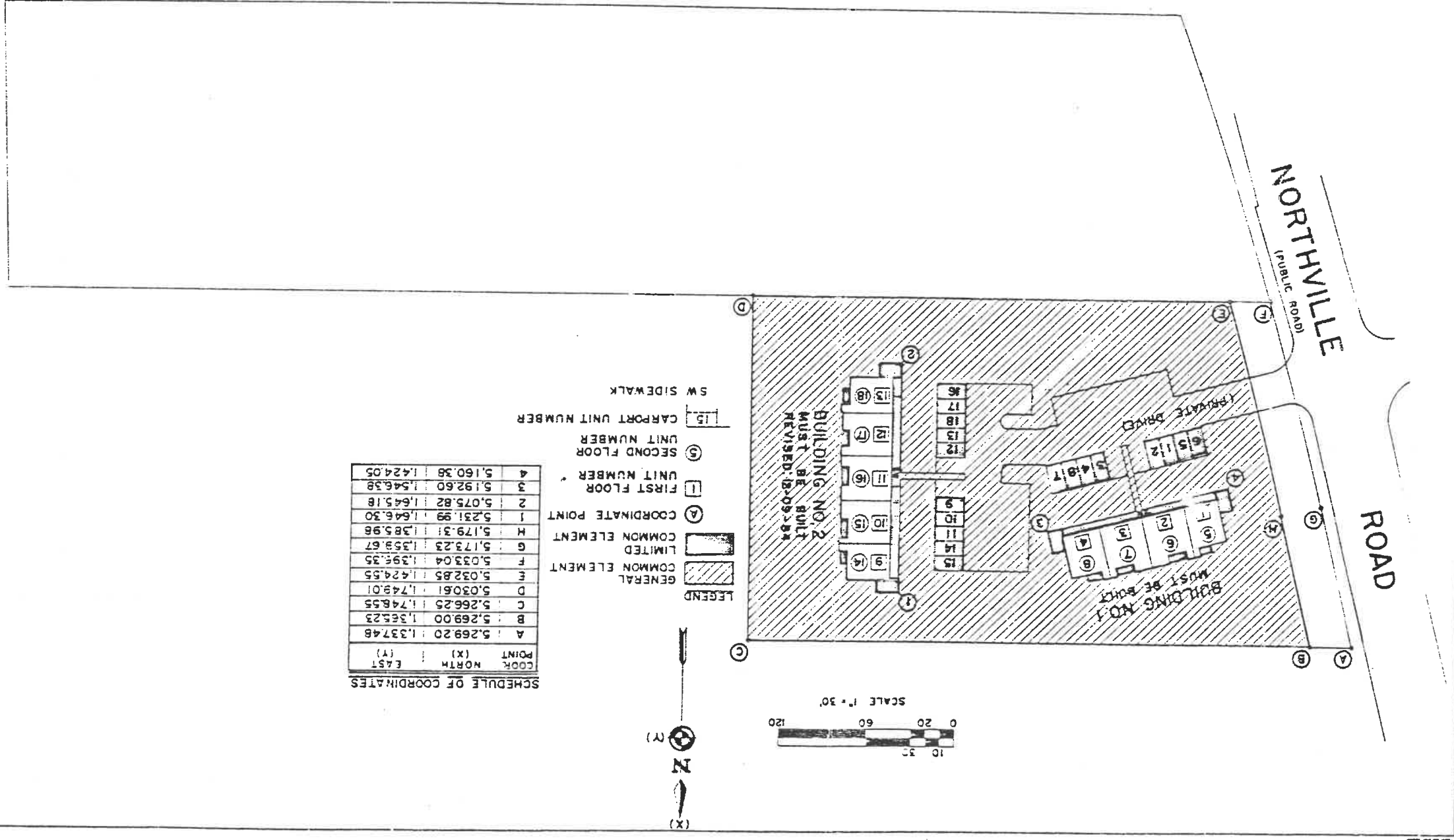

SCHEDULE OF COORDINATES

COORD. POINT	EAST (X)	NORTH (Y)
A	5,269.20	1,337.48
B	5,269.00	1,365.23
C	5,266.25	1,748.55
D	5,030.61	1,749.01
E	5,032.85	1,424.55
F	5,033.04	1,395.35
G	5,173.23	1,359.67
H	5,179.31	1,385.98
I	5,231.99	1,646.30
J	5,075.82	1,645.18
K	5,192.60	1,546.38
L	5,160.38	1,424.05

- LEGEND
- GENERAL ELEMENT
  - COMMON ELEMENT
  - LIMITED COMMON ELEMENT
  - COORDINATE POINT
  - FIRST FLOOR UNIT NUMBER
  - SECOND FLOOR UNIT NUMBER
  - CARPORT UNIT NUMBER
  - SW SIDEWALK

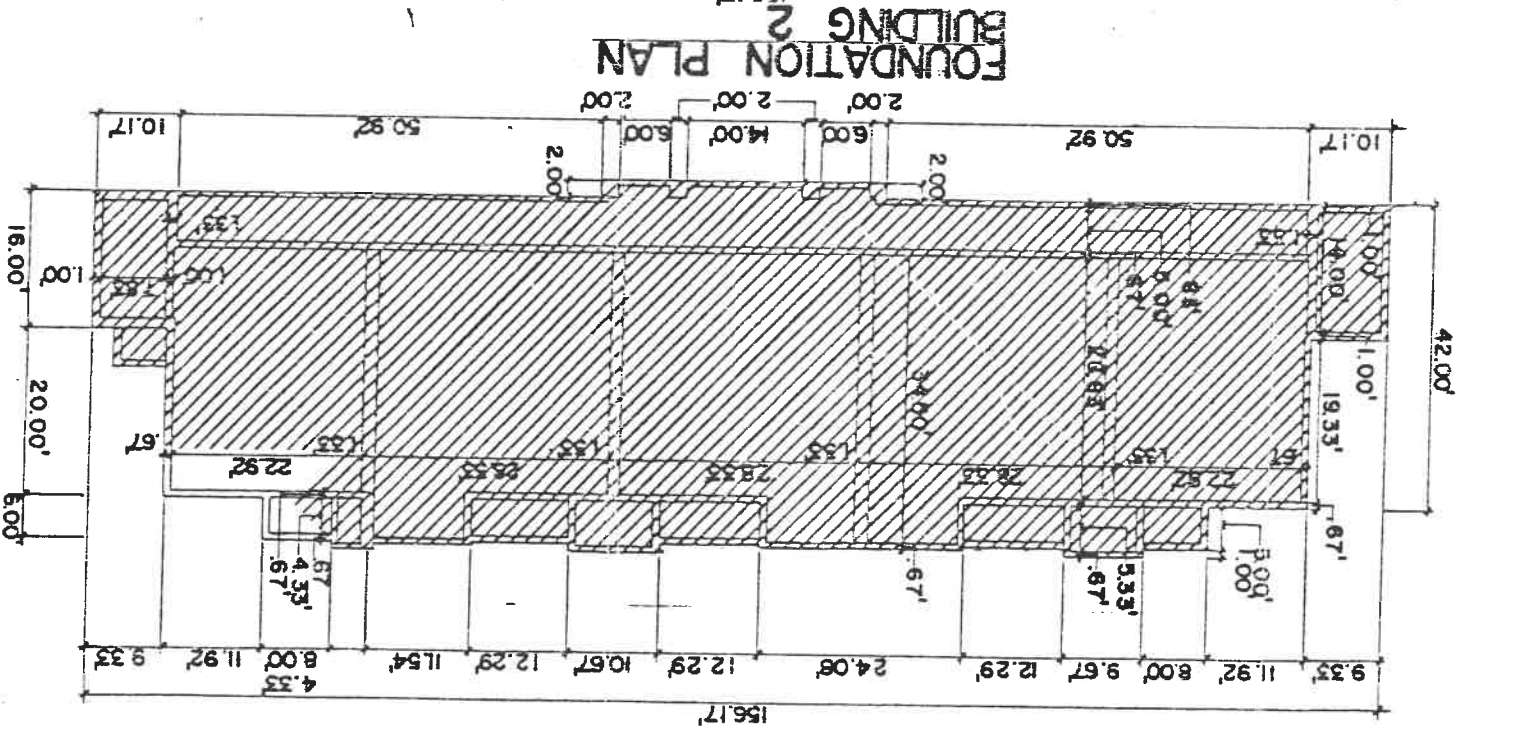

FOUNDATION PLAN  
BUILDING 2

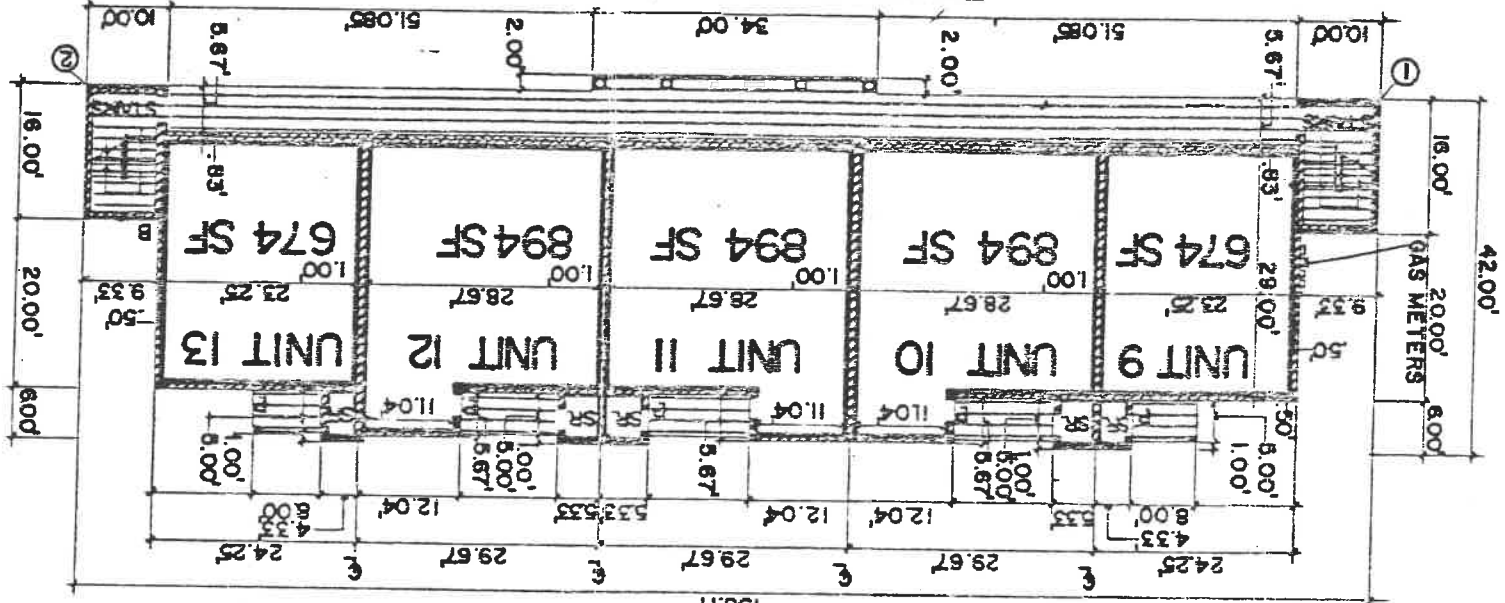

FIRST FLOOR PLAN  
BUILDING 2

CHARWOOD CONDOMINIUM

REVISED: 12-09-84 BUILDING 2  
MUST BE BUILT

MICHAEL L. PRIEST  
REGISTERED LAND SURVEYOR  
MICHAEL L. PRIEST & ASSOCIATES INC.  
12590 FARMINGTON ROAD  
LYONIA, MICHIGAN 48150

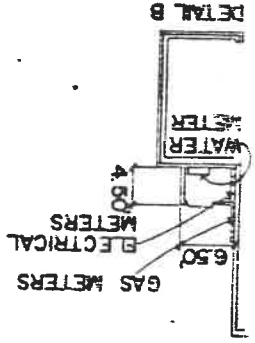
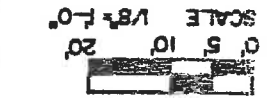

- LEGEND**
- ▨ GENERAL COMMON ELEMENT
  - ▩ LIMITED COMMON ELEMENT
  - LIMITS OF OWNERSHIP
  - SR STORAGE ROOM
  - P PATIO—LIMITED COMMON ELEMENT
  - ALL WALLS AT RIGHT ANGLES
  - SF AREA IN SQUARE FEET DOES NOT INCLUDE STORAGE ROOM

THIRD AMENDMENT TO MASTER DEED  
OF CHARNWOOD

CHARNWOOD GROUP, a Michigan Co-Partnership, being the Developer of Charnwood, a condominium project established pursuant to the Master Deed thereof, recorded on June 18, 1984, in Liber 22045, Pages 553-571, as amended by the First Amendment to Master Deed of Charnwood recorded on August 17, 1984, in Liber 22112, Pages 874 and 875, and as amended by the Second Amendment to Master Deed of Charnwood recorded on January 9, 1985, in Liber 22248, Page 936, Wayne County Records, and known as Wayne County Condominium Subdivision Plan No. 190, hereby amends the Master Deed Article VIII (g) of Charnwood pursuant to the authority reserved in Article IX (c)(1) of the Master Deed for the purpose of expanding the Condominium Project from 18 units to 62 units by the addition of the buildings described as must be built and reallocating the percentages of value set forth in Article VI of the Master Deed. Upon the recordation in the Office of Wayne County Register of Deeds of this Amendment, Exhibit C, as recorded in Liber 22045, Page 571, shall be eliminated and replaced with new Exhibit C, and the Master Deed shall be amended in the following manner:

1. Article VI of the Master Deed of Charnwood as set forth below, shall replace and supersede Article VI of the Master Deed as recorded, and Article VI as originally recorded shall be of no further force or effect

This is to certify that there are no tax liens or other property and that taxes are paid by FIVE YEARS previous to date of this instrument EXCEPT  
1969  
JUN 17 1986  
Wayne County Treasurer  
Cek

AMENDED ARTICLE VI OF MASTER DEED

CONDOMINIUM UNIT DESCRIPTION AND PERCENTAGE OF VALUE

A. The Condominium consists of sixty-two (62) units. Each condominium unit is described in this paragraph with reference to the Condominium Subdivision Plan attached hereto as Exhibit B and Exhibit C. Each Condominium unit shall include all that space contained within the interior side of the finished, unpainted perimeter walls, and within the ceilings and finished subfloor, all as shown on Exhibit B and Exhibit C and delineated with heavy outlines. For all purposes, individual units may hereafter be defined and described by reference to this Master Deed and the individual number assigned to the unit in the Condominium Subdivision Plan.

B. The percentage of value assigned to each unit is set forth in this Article and shall be determinative of the proportionate share of each respective co-owner in the proceeds and expenses of the administration (except as provided in Article IV (c) above) and the value of such co-owner's vote at meetings of the Association and the undivided interest of the co-owner in the common elements. The total percentage value of the Condominium is 100%. Individual unit percentages of value shall be as follows:

Schedule of Percentages of Value			
Unit Numbers According to Plan	Percentage For Each Unit	Unit Numbers According to Plan	Percentage For Each Unit
1	1.321	19	1.321
2	1.752	20	1.752
3	1.752	21	1.752
4	1.321	22	1.752
5	1.321	23	1.752
6	1.752	24	1.321
7	1.752	25	1.321
8	1.321	26	1.752
9	1.321	27	1.752
10	1.752	28	1.752
11	1.752	29	1.752
12	1.752	30	1.321
13	1.321	31	1.321
14	1.321	32	1.752
15	1.752	33	1.752
16	1.752	34	1.752
17	1.752	35	1.752
18	1.321	36	1.752

86 JUN 17 P12:49

Schedule of Percentages of Value (Cont'd.)

Unit Numbers According to Plan	Percentage For Each Unit	Unit Numbers According to Plan	Percentage For Each Unit
37	1.321	50	1.321
38	1.752	51	1.321
39	1.752	52	1.752
40	1.752	53	1.752
41	1.752	54	1.752
42	1.752	55	1.752
43	1.752	56	1.321
44	1.752	57	1.321
45	1.752	58	1.752
46	1.321	59	1.752
47	1.752	60	1.752
48	1.752	61	1.752
49	1.752	62	1.321

2. Replacement Exhibit C, sheets 1 through 10 of the Condominium Sub-division Plan of Charnwood Condominiums, is attached hereto.

In all respects, other than as hereinabove indicated, the original Master Deed of Charnwood, including the Bylaws and Condominium Subdivision Plan respectively attached thereto as Exhibits A and B, recorded as aforesaid, is hereby ratified.

WITNESSES:

Kimberlee A. Schaik  
 Kimberlee A. Schaik  
 ) S.S.  
 STATE OF MICHIGAN )  
 COUNTY OF OAKLAND )  
Vickilyn McMullen  
 Vickilyn McMullen

CHARNWOOD GROUP  
A Michigan Co-Partnership

By: James M. Burroughs  
 James M. Burroughs  
 Its: Partner

The foregoing instrument was acknowledged before me this 20th day of May, 19 86, by James M. Burroughs who is a Partner of Charnwood Group, a Michigan Co-Partnership, on behalf of the Co-Partnership.

Leslie A. Rebtov  
 Leslie A. Rebtov

Notary Public, Oakland County, MI  
 My Commission Expires: **LESLIE A. REBTOV**  
 Notary Public, Oakland County, MI  
 My Commission Expires Oct. 4, 1987

DRAFTED BY AND WHEN RECORDED, PLEASE RETURN TO:

James M. Burroughs  
 Charnwood Group  
 27830 Orchard Lake Rd., #203  
 Farmington Hills, MI 48018

LI 22810 PA 702

WAYNE COUNTY CONDOMINIUM  
SUBDIVISION PLAN No.

EXHIBIT C TO MASTER DEED OF

CHARNWOOD CONDOMINIUMS

A CONDOMINIUM  
PLYMOUTH TOWNSHIP, WAYNE COUNTY, MICHIGAN

DEVELOPER

CHARNWOOD GROUP  
A MICHIGAN CO-PARTNERSHIP  
27830 ORCHARD LAKE ROAD  
SUITE 203  
FARMINGTON HILLS, MICHIGAN  
48018

ENGINEER

LAVERN R. SCHRADER  
REGISTERED CIVIL ENGINEER  
REGISTRATION NO. 10461  
SCHRADER-PORTER & ASSOC., INC.  
27251 JOY ROAD  
DEARBORN HEIGHTS, MICHIGAN  
48127

INDEX TO SHEETS

1. COVER SHEET
2. SURVEY PLAN
3. SITE PLAN
4. UTILITY PLAN
5. BUILDING 3 & 6 FIRST FLOOR,  
BASEMENT AND FOUNDATION PLAN
6. BUILDING 3 & 6 SECOND FLOOR PLAN  
AND SECTION
7. BUILDING 4 FIRST FLOOR,  
BASEMENT AND FOUNDATION PLAN  
AND SECTION
8. BUILDING 4 SECOND FLOOR PLAN  
AND SECTION
9. BUILDING 5 FIRST FLOOR,  
BASEMENT AND FOUNDATION PLAN  
AND SECTION
10. BUILDING 5 SECOND FLOOR PLAN  
AND SECTION

I, LAVERN R. SCHRADER, Registered Civil Engineer of the State of Michigan, hereby certify:

That the subdivision plan known as WAYNE COUNTY SUBDIVISION PLAN NO. 22810, as shown on the accompanying drawings represents a survey on the ground made under my direction and that there are no existing encroachments upon the lands and properties herein described.

That the required monuments and iron markers have been located in the ground as required by rules promulgated under Section 142 of Act No. 59 of Public Acts of 1978.

That the accuracy of this survey is within the limits required by the rules promulgated under Section 142 of Act No. 59 of the Public Acts of 1978.

That the bearings as shown, are noted on survey plan as required by the rules promulgated under Section 142 of Act No. 59 of the Public Acts of 1978.

DATE

6/16/82

*Lavern R. Schrader*

LAVERN R. SCHRADER  
REGISTERED CIVIL ENGINEER  
REGISTRATION NO. 10461  
SCHRADER-PORTER & ASSOC., INC.  
27251 JOY ROAD  
DEARBORN HEIGHTS, MICHIGAN  
48127



ATTENTION COUNTY REGISTRAR OF DEEDS  
THE CONDOMINIUM SUBDIVISION PLAN NUMBER MUST  
BE IN CONSECUTIVE SEQUENCE. WHEN A NUMBER HAS  
BEEN ASSIGNED TO THIS PROJECT, IT MUST BE  
PROPERLY SHOWN IN THE TITLE. SHEET 1 AND  
SUPERVISOR'S CERTIFICATE, SHEET 2.



NORTHVILLE ROAD 120 FT. WIDE

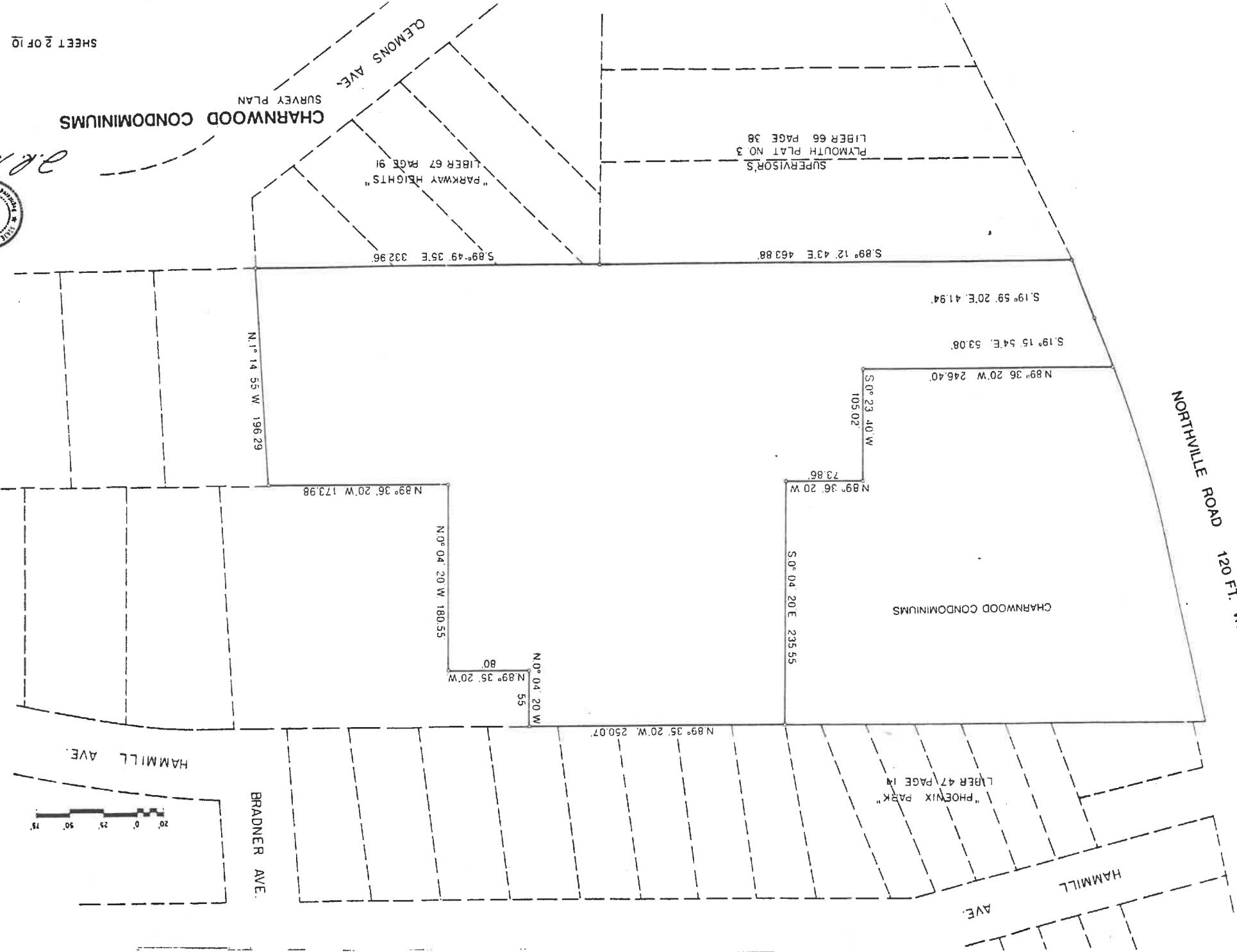

CHARWOOD CONDOMINIUMS SURVEY PLAN



*J.R. Johnson*

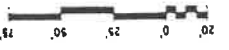

N

SCHEDULE OF COORDINATES

COORD POINT	NORTH (X)	EAST (Y)
A	10,000.00	10,466.02
B	9993.57	10,466.02
C	9992.56	10,793.16
D	10,188.77	10,793.16
E	10,189.97	10,619.19
F	10,370.52	10,618.96
G	10,371.09	10,536.96
H	10,426.09	10,536.89
I	10,427.88	10,288.83
J	10,192.33	10,289.13
K	10,192.84	10,215.27
L	10,087.82	10,214.54
M	10,089.52	9,968.15
N	10,039.41	9,982.56
O	10,071.18	10,360.39
P	10,071.00	10,595.26

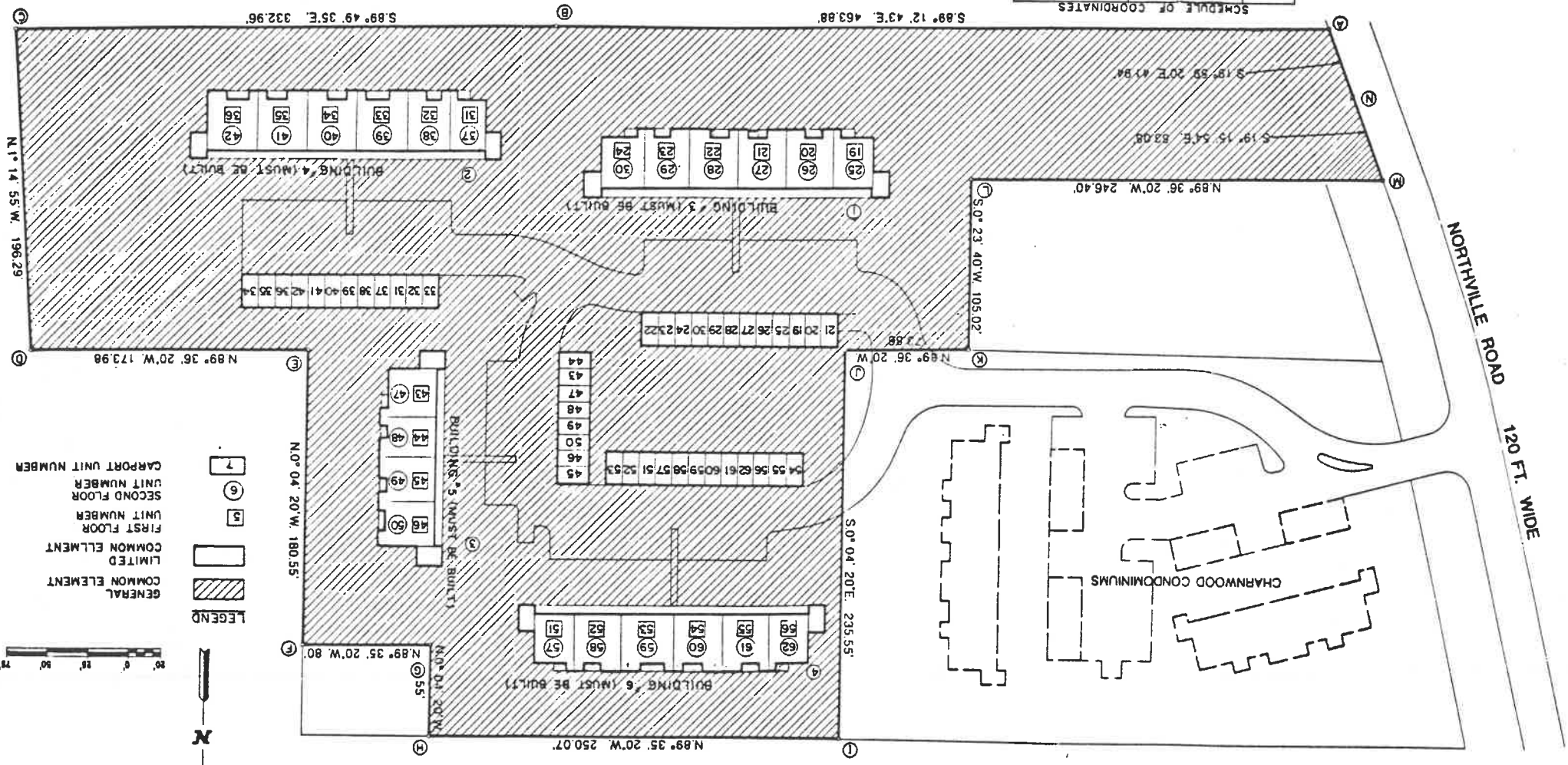

CHARWOOD CONDOMINIUMS  
SITE PLAN

NORTHVILLE ROAD  
120 FT. WIDE

CHARWOOD CONDOMINIUMS

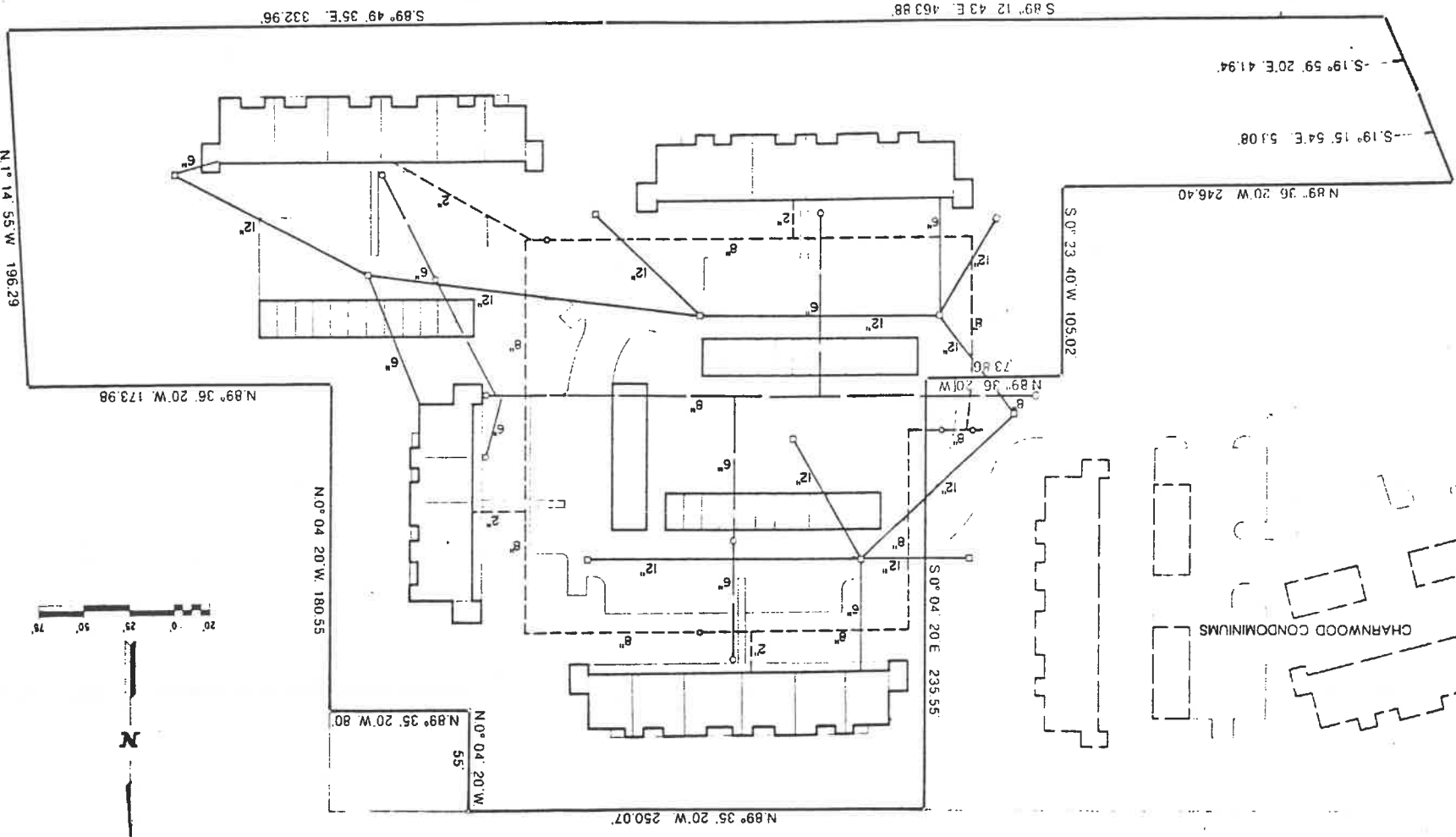

LEGEND  
 --- STORM SEWER  
 - - - - - SANITARY SEWER  
 - · - · - · WATER MAIN

CHARWOOD CONDOMINIUMS  
 UTILITIES PLAN

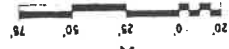

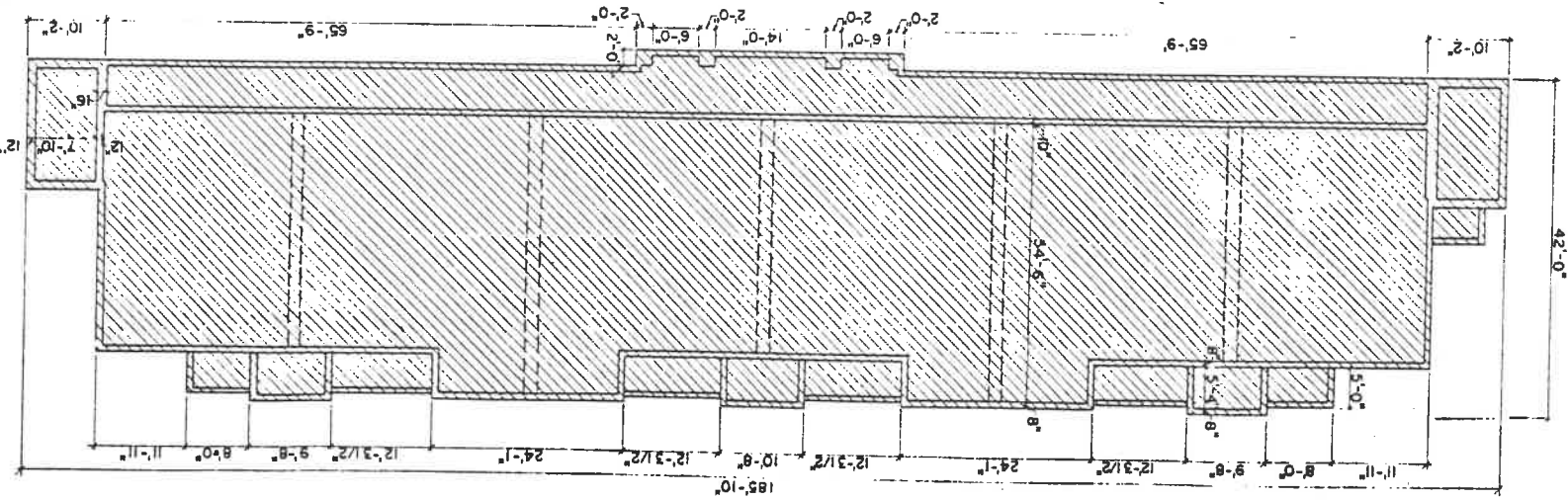

FOUNDATION PLAN  
BUILDINGS 3, 4, 5, 6

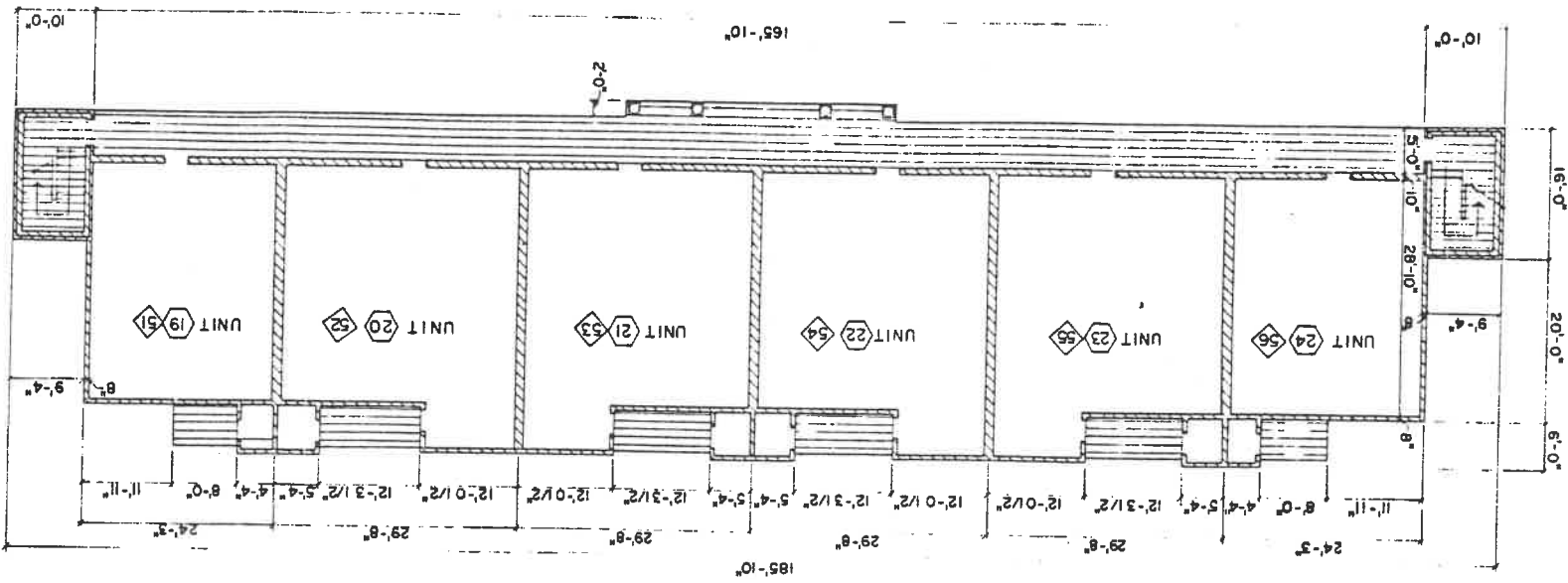

FIRST FLOOR PLAN  
BUILDINGS 3, 4, 5, 6



LEGEND

-  GENERAL COMMON ELEMENT
-  LIMITED COMMON ELEMENT

— LIMITS OF OWNERSHIP

S. R. STORAGE ROOM

B. BALCONY LIMITED COMMON ELEMENT

ALL WALLS AT RIGHT ANGLES

S. F. AREA IN SQUARE FEET DOES NOT INCLUDE STORAGE ROOM

 BUILDING 3, UNIT NUMBER

 BUILDING 6, UNIT NUMBER



*R. J. Brown*

*R. R. ...*



CHARWOOD CONDOMINIUMS

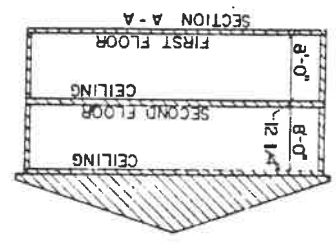

- LEGEND**
- GENERAL COMMON ELEMENT
  - LIMITED COMMON ELEMENT
  - LIMITS OF OWNERSHIP
  - S.R. STORAGE ROOM
  - B. BALCONY LIMITED COMMON ELEMENT
  - S.F. AREA IN SQUARE FEET DOES NOT INCLUDE STORAGE ROOM
  - ◇ 25 BUILDING 3, UNIT NUMBER
  - ◇ 57 BUILDING 6, UNIT NUMBER

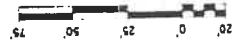

SECOND FLOOR PLAN  
BUILDINGS "3" & "6"

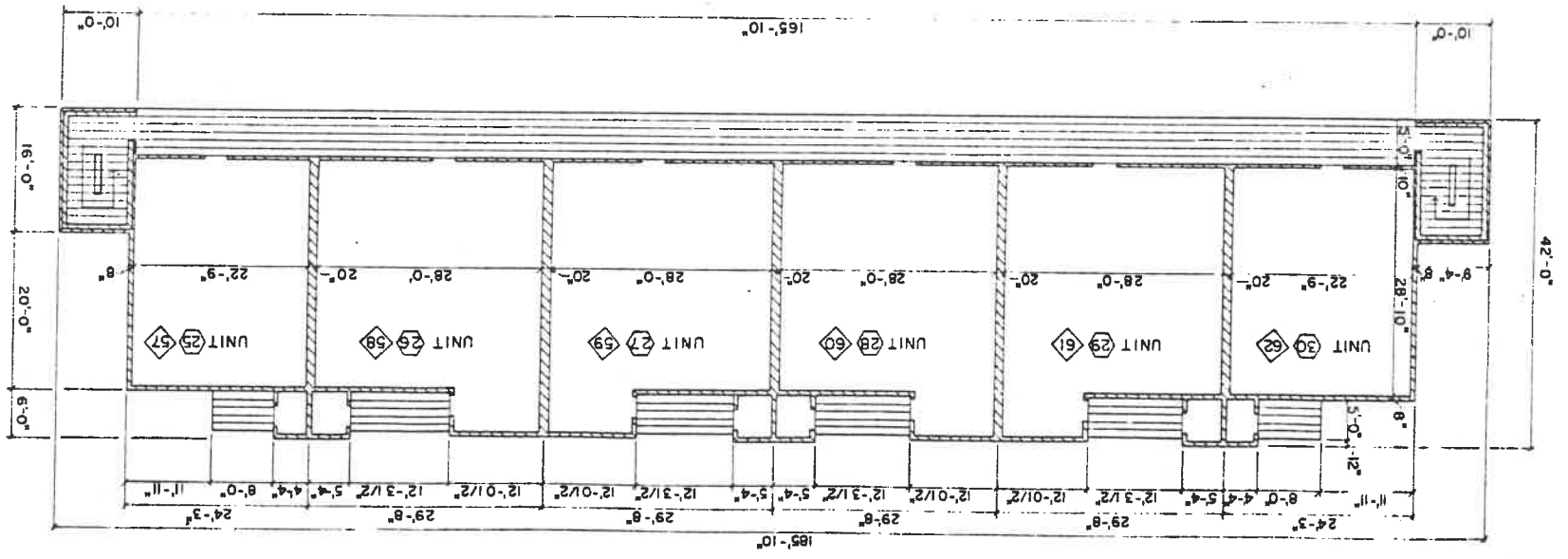

L 22810 PA 707

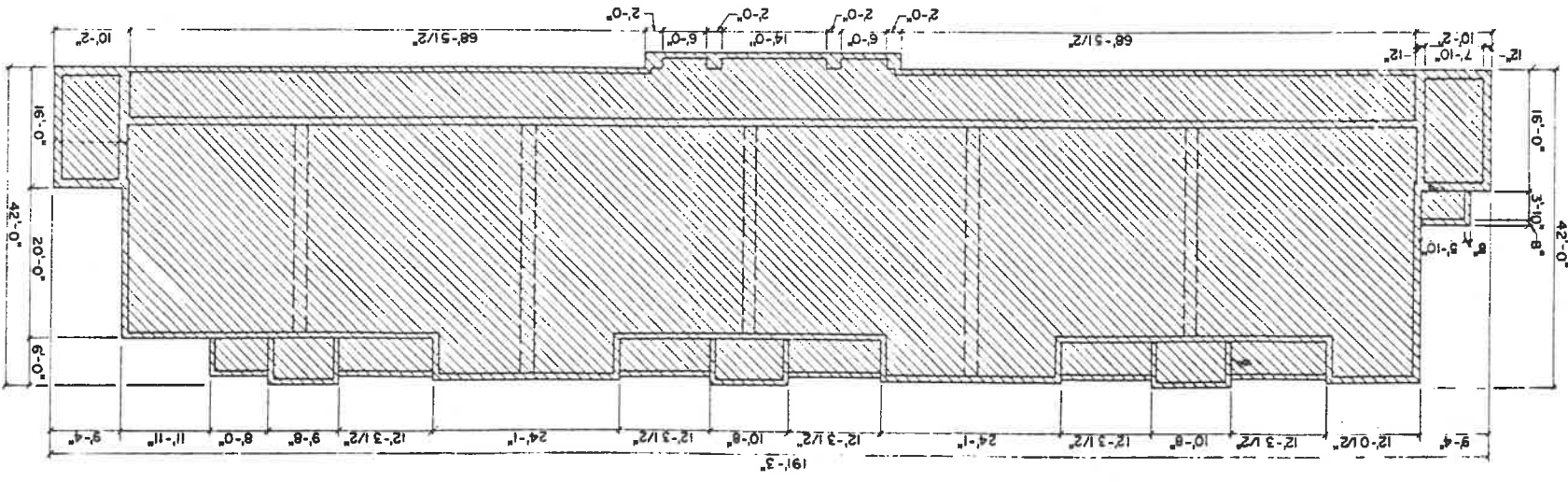
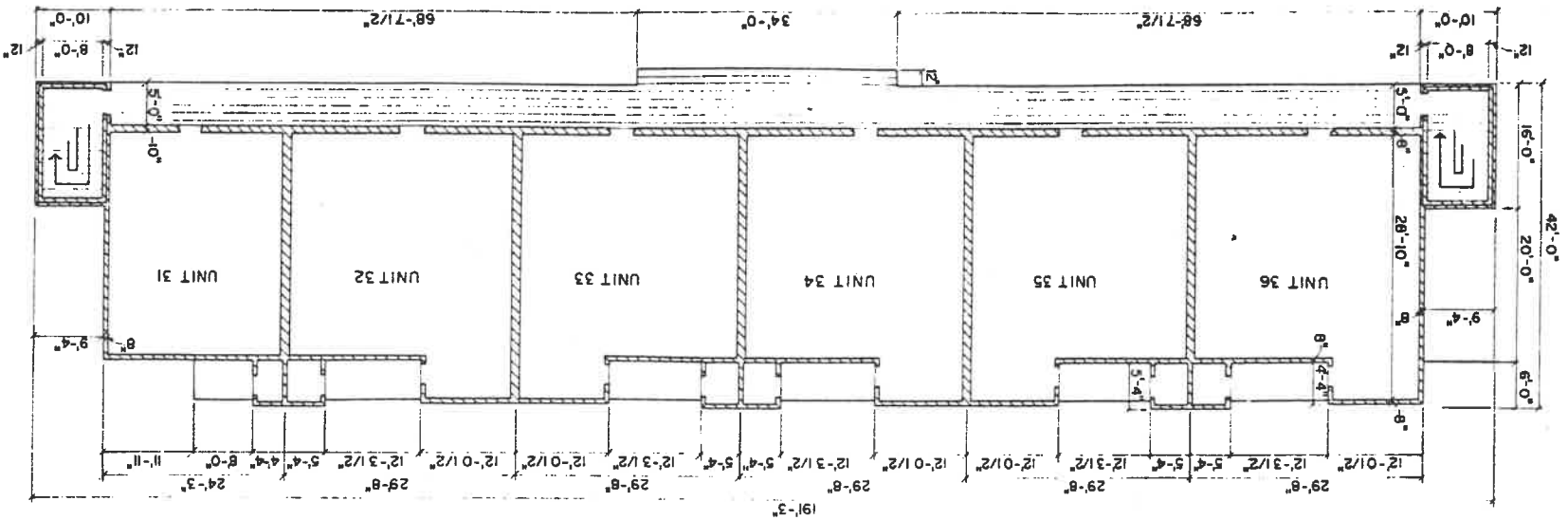

- S.F. AREA IN SQUARE FEET DOES NOT INCLUDE ANGLES
- B. BALCONY LIMITED COMMON ELEMENT
- S.R. STORAGE ROOM
- LIMITS OF OWNERSHIP
- ▨ ELEMENT LIMITED COMMON
- ▨ ELEMENT GENERAL COMMON

LEGEND

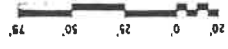

*Handwritten signature*

*D.R. Moore*



LEGEND

GENERAL COMMON ELEMENT

LIMITED COMMON ELEMENT

LIMITS OF OWNERSHIP

S.R. STORAGE ROOM

B. BALCONY LIMITED COMMON ELEMENT

S.F. AREA IN SQUARE FEET DOES NOT INCLUDE STORAGE ROOM

ALL WALLS AT RIGHT ANGLES

CHARNWOOD CONDOMINIUMS

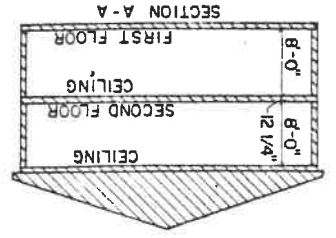

SECOND FLOOR PLAN BUILDING "A"

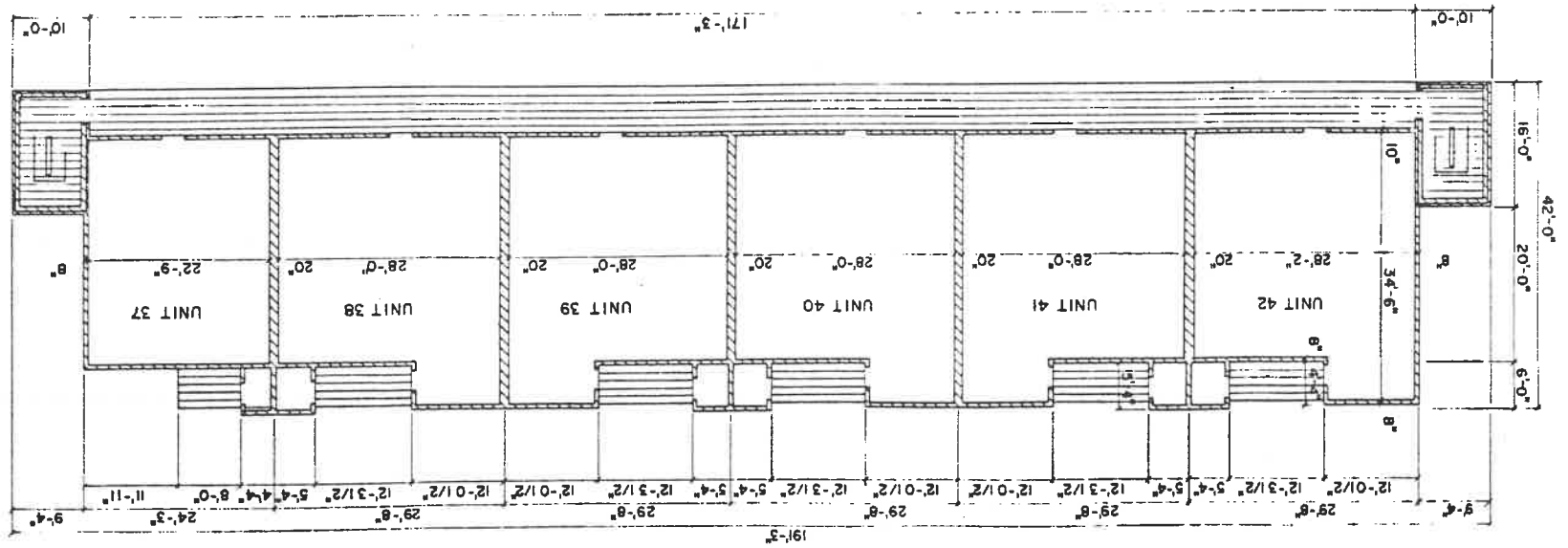

*J.R. Muecke*

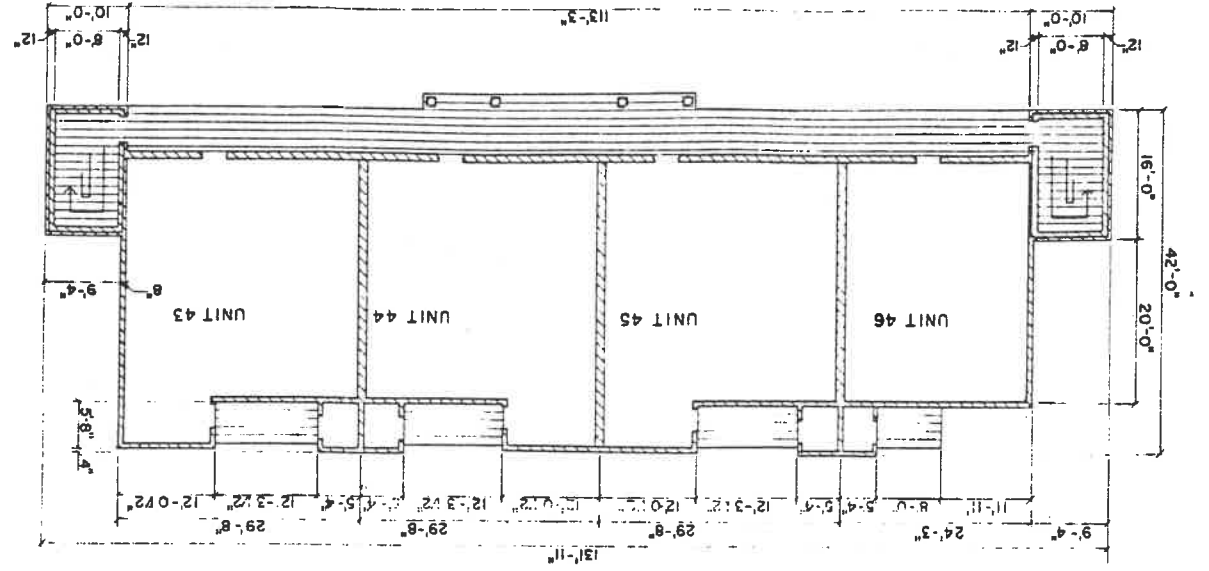

FOUNDATION PLAN  
BUILDING 5

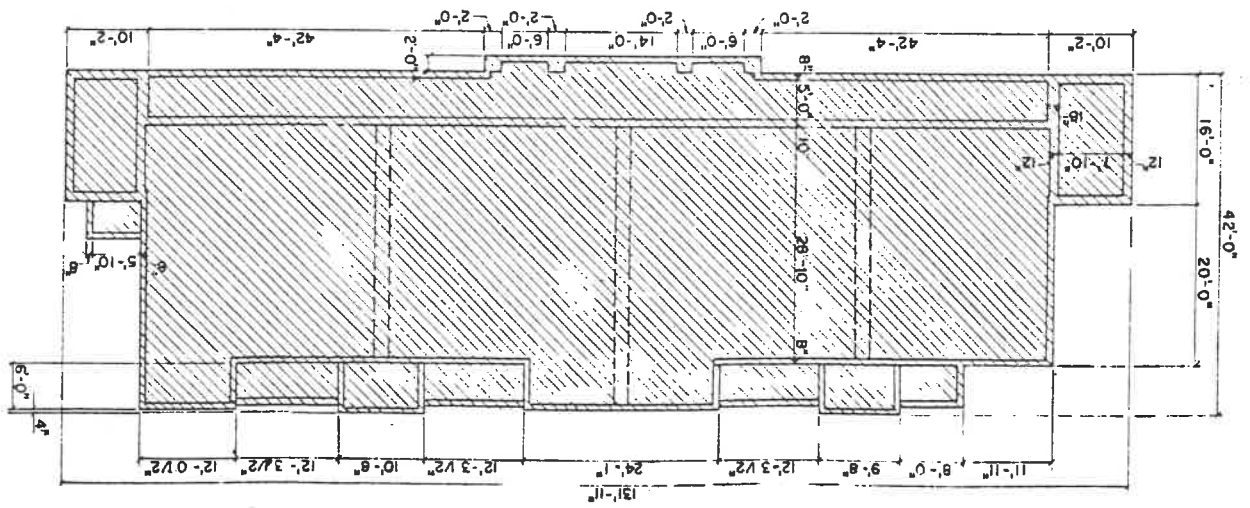

- LEGEND**
- ▨ GENERAL COMMON ELEMENT
  - ▤ LIMITED COMMON ELEMENT
  - LIMITS OF OWNERSHIP
  - S.R. STORAGE ROOM
  - B. BALCONY LIMITED COMMON ELEMENT
  - ALL WALLS AT RIGHT ANGLES
  - S.F. AREA IN SQUARE FEET DOES NOT INCLUDE STORAGE ROOM

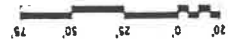

LI 22810 PA 710



*D. J. ...*



**LEGEND**

GENERAL COMMON ELEMENT

LIMITED COMMON ELEMENT

LIMITS OF OWNERSHIP

S. R. STORAGE ROOM

B. BALCONY LIMITED COMMON ELEMENT

S.F. AREA IN SQUARE FEET DOES NOT INCLUDE STORAGE ROOM

ALL WALLS AT RIGHT ANGLES

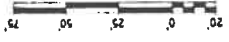

CHARNWOOD CONDOMINIUMS

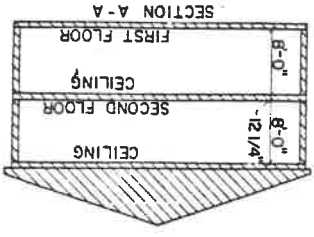

SECOND FLOOR PLAN BUILDING "5"

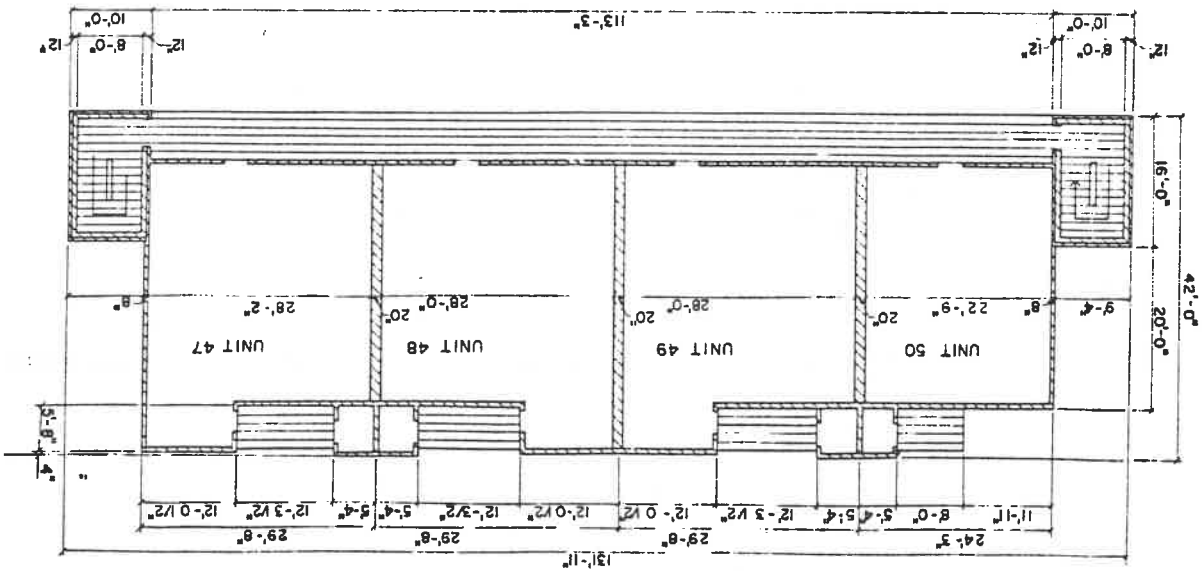

L122810 PA 711

2

56200806

2007/1/1

FOURTH AMENDMENT TO MASTER DEED  
OF CHARNWOOD

Plan #190

L122845 PM 059

J.M.B. & ASSOCIATES, a Michigan Corporation, being the Developer (developer formerly known as Charnwood Group, a Michigan Co-Partnership, which was duly dissolved with full rights as developer being assigned to J.M.B. & Associates, Inc.) of Charnwood, a condominium project established pursuant to the Master Deed thereof, recorded on June 18, 1984, in Liber 22045, Pages 553-571, as amended by the First Amendment to Master Deed of Charnwood recorded on August 17, 1984, in Liber 22112, Pages 874 and 875, and as amended by the Second Amendment to Master Deed of Charnwood recorded on January 9, 1985, in Liber 22248, Page 936, and as amended by the Third Amendment to Master Deed of Charnwood recorded on June 17, 1986 in Liber 22810, Pages 700-711, Wayne County Records, and known as Wayne County Condominium Subdivision Plan No. 190, hereby amends the Master Deed Article II of Charnwood pursuant to the authority reserved in Article IX (c)(1) of the Master Deed for the purpose of adding additional land to the legal description. Additionally, Exhibit C, pages 1-10, as recorded on June 17, 1986 in Liber 22810, Pages 702-711, shall be amended to correct an improper legal on Pages 1 - 4. The Master Deed shall be amended in the following manner:

1. The following shall be added to Article II:

Charnwood Condominiums being a part of Lots 47 and 48 of Supervisor's Plymouth Plat No. 3 of Holcomb's Addition to the Village of Plymouth and part of Section 23, T1S, R8E, Plymouth Twp., Wayne County, Michigan. As recorded in L. 66, P. 38 Plats, Wayne County Records, being more particularly described as: Beginning at the SW corner of Lot 47 thence along S'ly line of Said Lot 47, South 89 degrees 12 minutes 43 seconds East 463.88 ft.; Thence South 89 degrees 49 minutes 12 minutes East 332.96 ft.; Thence North 1 degree 41 minutes 55 seconds West 196.29 ft.; Thence North 89 degrees 36 minutes 20 seconds West 173.98 ft.; Thence North 0 degrees 04 minutes 20 seconds West 180.55 ft.; Thence North 89 degrees 35 minutes 20 seconds West 80 ft.; Thence No. 0 degrees 04 minutes 20 seconds West 55 ft.; Thence North 89 degrees 35 minutes 20 seconds West 250.07 ft.; Thence South 0 degrees 04 minutes 20 seconds East 235.55 ft.; Thence North 89 degrees 36 minutes 20 seconds West 73.86 ft.; Thence South 0 degrees 23 minutes 40 seconds West 105.02 ft.; Thence North 89 degrees 36 minutes 20 seconds West 246.40 ft.; to the Easterly line of Northville Road (66 ft. wide); Thence South 19 degrees 15 minutes 54 seconds East 53.08 ft. along the Easterly line of Northville Road; Thence South 19 degrees 59 minutes 20 seconds East 41.94 ft. along the Easterly line of Northville Road to the point of Beginning.

In all respects, other than as hereinabove indicated, the original Master Deed of Charnwood, including the Bylaws and Condominium Subdivision Plan respectively attached thereto, as Exhibits A and B, recorded as foregoing, is hereby ratified.

WITNESSES:

*Leslie A. Rebtby*  
Leslie A. Rebtby  
*Kimberlee A. Schalk*  
Kimberlee A. Schalk  
STATE OF MICHIGAN  
COUNTY OF OAKLAND)  
) S.S.

*James M. Burroughs*  
By: James M. Burroughs  
President  
Its: \_\_\_\_\_  
Notary Public, Oakland County, MI  
My Commission Expires: \_\_\_\_\_

The foregoing instrument was acknowledged before me this 7th day of July, 1986, by James M. Burroughs who is President of J.M.B. & Associates, Inc., a Michigan Corporation.

*Leslie A. Rebtby*  
Leslie A. Rebtby  
Notary Public, Oakland County, MI  
My Commission Expires: \_\_\_\_\_

DRAFTED BY AND WHEN RECORDED, PLEASE RETURN TO:  
J.M.B. & Associates, Inc.  
27830 Orchard Lake Rd., #203  
Farmington Hills, MI 48018  
LESLIE A. REBTBY  
Notary Public, Oakland County, MI  
My Commission Expires Oct. 4, 1987

56200806

86 JUL 18 PM 4:11

110710/0

WAYNE COUNTY CONDOMINIUM  
SUBDIVISION PLAN No.

EXHIBIT C TO MASTER DEED OF

CHARNWOOD CONDOMINIUMS

A CONDOMINIUM  
PLYMOUTH TOWNSHIP, WAYNE COUNTY, MICHIGAN

DEVELOPER

CHARNWOOD GROUP  
A MICHIGAN CO-PARTNERSHIP,  
27830 ORCHARD LAKE ROAD  
SUITE 203  
FARMINGTON HILLS, MICHIGAN  
48018

ENGINEER

LAVERN R. SCHRADER  
REGISTERED CIVIL ENGINEER  
REGISTRATION No. 10461  
SCHRADER-PORTER & ASSOC., INC.  
27251 JOY ROAD  
DEARBORN HEIGHTS, MICHIGAN  
48127

LEGAL DESCRIPTION

CHARNWOOD CONDOMINIUMS BEING A PART OF LOTS 47 AND 48 OF SUPERVISOR'S PLYMOUTH PLAT No. 3 OF HOLCOMB'S ADDITION TO THE VILLAGE OF PLYMOUTH AND PART OF SECTION 23, T.1 S., R.8 E., PLYMOUTH TWP., WAYNE COUNTY, MICHIGAN, AS RECORDED IN L. 66, P. 38 PLATS, WAYNE COUNTY RECORDS, BEING MORE PARTICULARLY DESCRIBED AS: BEGINNING AT THE SW CORNER LOT 47 THENCE ALONG S'LY LINE OF SAID LOT 47, SOUTH 89 DEGREES 12 MINUTES 43 SECONDS EAST 463.88 FT., THENCE SOUTH 89 DEGREES 49 MINUTES 35 SECONDS EAST 332.96 FT., THENCE NORTH 1 DEGREE 41 MINUTES 55 SECONDS WEST 196.29 FT., THENCE NORTH 89 DEGREES 36 MINUTES 20 SECONDS WEST 173.98 FT., THENCE NORTH 00 DEGREES 04 MINUTES 20 SECONDS WEST 180.55 FT., THENCE NORTH 89 DEGREES 35 MINUTES 20 SECONDS WEST 80 FT., THENCE NORTH 0 DEGREES 04 MINUTES 20 SECONDS WEST 55 FT., THENCE NORTH 89 DEGREES 35 MINUTES 20 SECONDS WEST 250.07 FT., THENCE SOUTH 0 DEGREES 04 MINUTES 20 SECONDS EAST 235.55 FT., THENCE NORTH 89 DEGREES 36 MINUTES 20 SECONDS WEST 73.86 FT., THENCE SOUTH 0 DEGREES 23 MINUTES 40 SECONDS WEST 105.02 FT., THENCE NORTH 89 DEGREES 35 MINUTES 20 SECONDS WEST 246.40 FT., TO THE EASTERLY LINE OF NORTHVILLE ROAD (66 FT. WIDE), THENCE SOUTH 19 DEGREES 15 MINUTES 54 SECONDS EAST 53.08 FT. ALONG THE EASTERLY LINE OF NORTHVILLE ROAD, THENCE SOUTH 19 DEGREES 59 MINUTES 20 SECONDS EAST 41.94 FT. ALONG THE EASTERLY LINE OF NORTHVILLE ROAD TO THE POINT OF BEGINNING.

ENGINEER'S CERTIFICATE

I, LAVERN R. SCHRADER, REGISTERED CIVIL ENGINEER OF THE STATE OF MICHIGAN, HEREBY CERTIFY:

THAT THE SUBDIVISION PLAN KNOWN AS WAYNE COUNTY SUBDIVISION PLAN No. \_\_\_\_\_ AS SHOWN ON THE ACCOMPANYING DRAWINGS REPRESENTS A SURVEY ON THE GROUND MADE UNDER MY DIRECTION AND THAT THERE ARE NO EXISTING ENCROACHMENTS UPON THE LANDS AND PROPERTIES HEREIN DESCRIBED.

THAT THE REQUIRED MONUMENTS AND IRON MARKERS HAVE BEEN LOCATED IN THE GROUND AS REQUIRED BY RULES PROMULGATED UNDER SECTION 142 OF ACT No. 59 OF PUBLIC ACTS OF 1978.

THAT THE ACCURACY OF THIS SURVEY IS WITHIN THE LIMITS REQUIRED BY THE RULES PROMULGATED UNDER SECTION 142 OF ACT No. 59 OF THE PUBLIC ACTS OF 1978.

THAT THE BEARINGS AS SHOWN, ARE NOTED ON SURVEY PLAN AS REQUIRED BY THE RULES PROMULGATED UNDER SECTION 142 OF ACT No. 59 OF THE PUBLIC ACTS OF 1978.

DATE

*Lavern R. Schrader*  
LAVERN R. SCHRADER  
REGISTERED CIVIL ENGINEER  
REGISTRATION No. 10461  
SCHRADER-PORTER & ASSOC., INC.  
27251 JOY ROAD  
DEARBORN HEIGHTS, MICHIGAN  
48127

ATTENTION: COUNTY REGISTRAR OF DEEDS

THE CONDOMINIUM SUBDIVISION PLAN NUMBER MUST BE IN CONSECUTIVE SEQUENCE. WHEN A NUMBER HAS BEEN ASSIGNED TO THIS PROJECT, IT MUST BE PROPERLY SHOWN IN THE TITLE, SHEET 1 AND SUPERVISOR'S CERTIFICATE, SHEET 2.

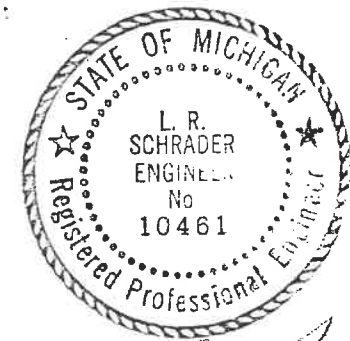

*L. R. Schrader*

INDEX TO SHEETS

1. COVER SHEET
2. SURVEY PLAN
3. SITE PLAN
4. UTILITY PLAN
5. BUILDING 3 & 6 FIRST FLOOR, BASEMENT AND FOUNDATION PLAN
6. BUILDING 3 & 6 SECOND FLOOR PLAN AND SECTION
7. BUILDING 4 FIRST FLOOR, BASEMENT AND FOUNDATION PLAN
8. BUILDING 4 SECOND FLOOR PLAN AND SECTION
9. BUILDING 5 FIRST FLOOR, BASEMENT AND FOUNDATION PLAN
10. BUILDING 5 SECOND FLOOR PLAN AND SECTION

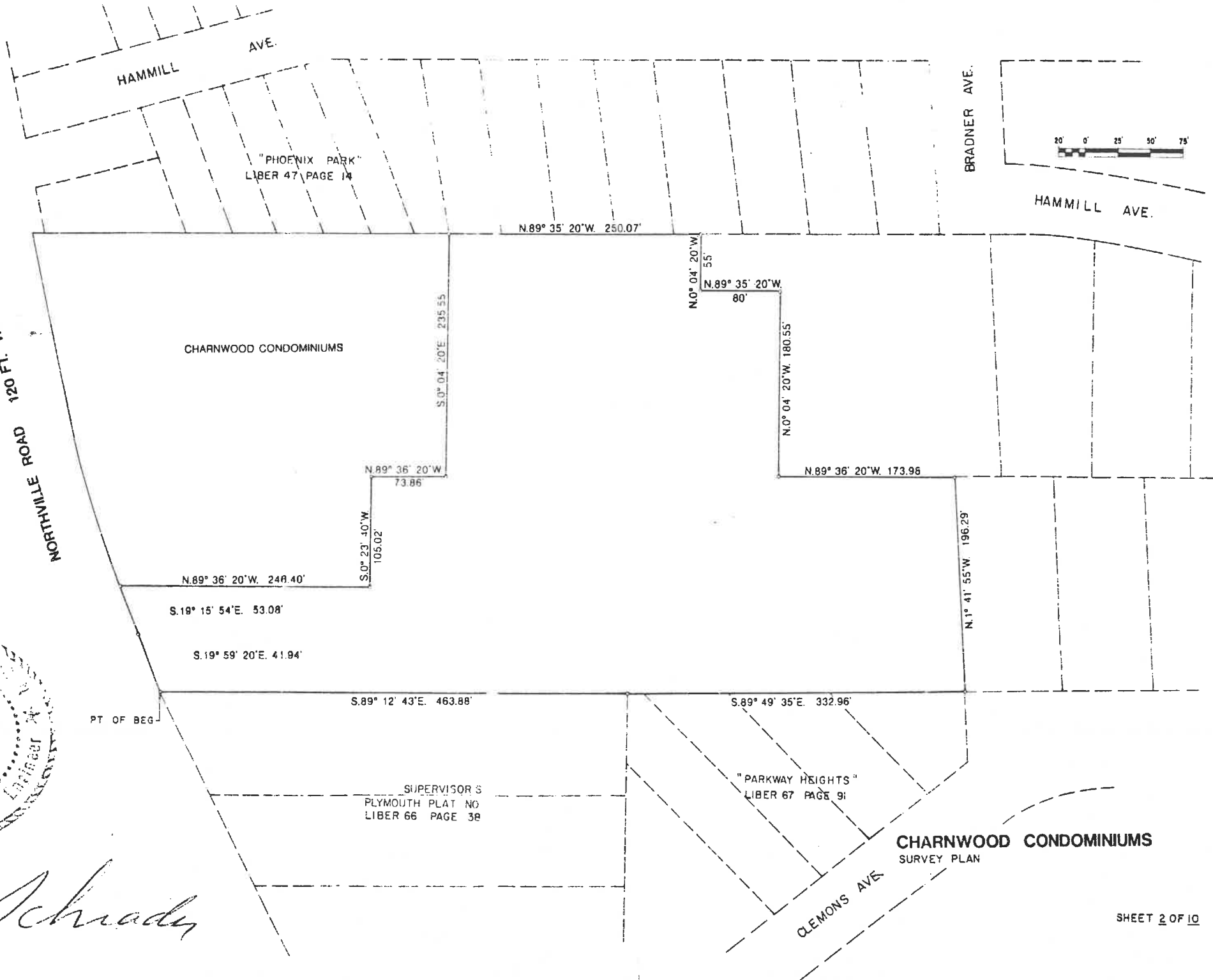

*L.R. Schrader*

**CHARNWOOD CONDOMINIUMS**  
SURVEY PLAN

1122845/061

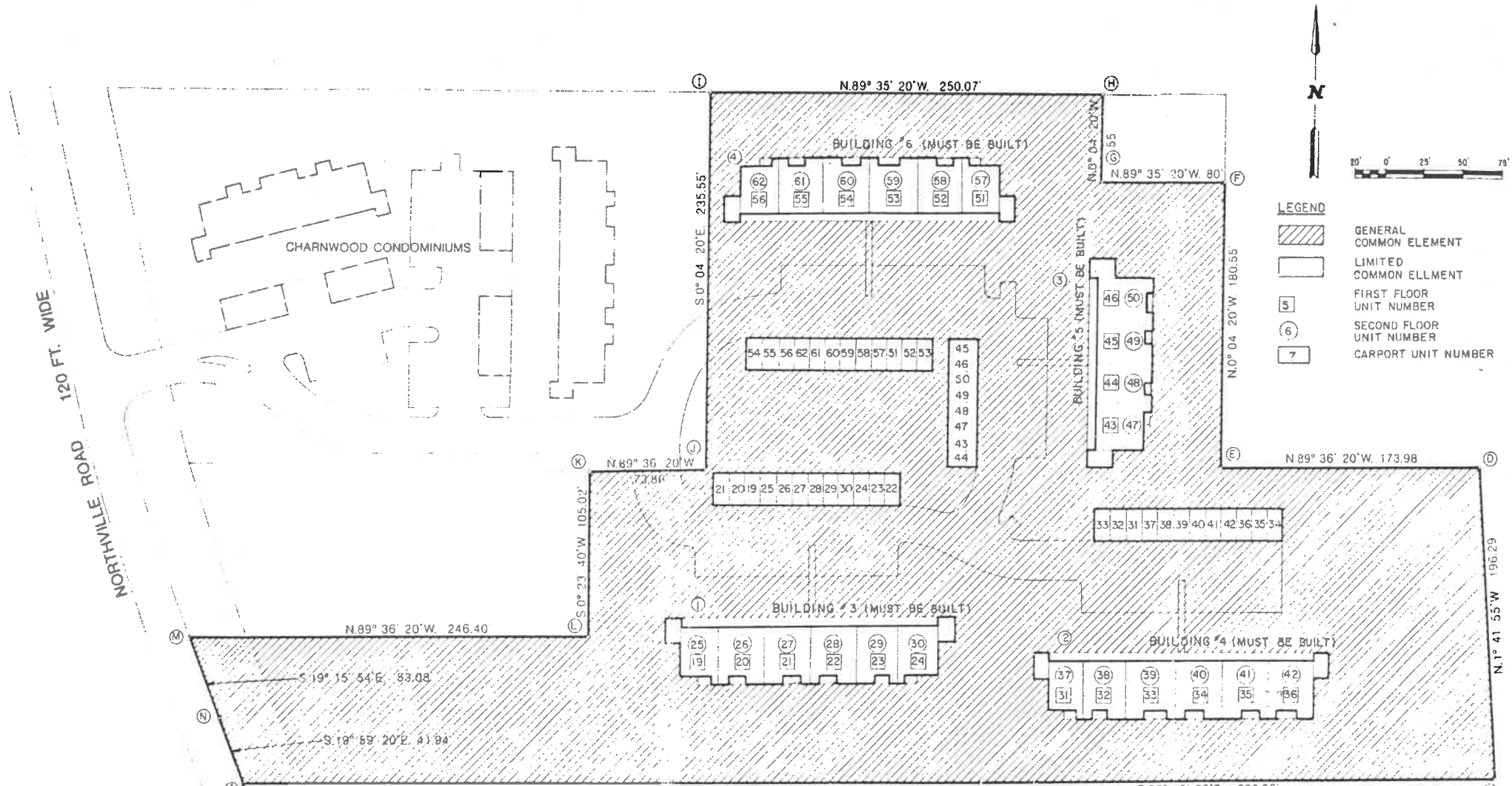

**SCHEDULE OF COORDINATES**

COORD POINT	NORTH (X)	EAST (Y)
A	10,000.00	10,000.00
B	9993.57	10,466.02
C	9982.56	10,798.98
D	10,188.77	10,743.16
E	10,189.97	10,619.14
F	10,270.52	10,619.96
G	10,371.09	10,548.94
H	10,426.09	10,538.89
I	10,427.88	10,798.43
J	10,192.33	10,285.73
K	10,192.84	10,215.27
L	10,087.82	10,214.54
M	10,089.52	9,969.12
N	10,032.41	9985.66
O	10,043.96	10,340.39
P	10,071.18	10,504.26
Q	10,311.09	10,340.74
R	10,382.74	10,308.51

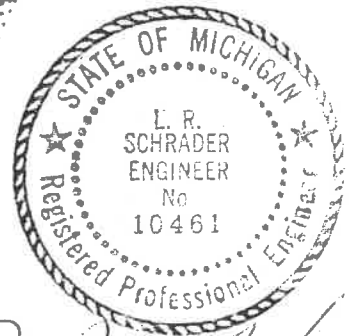

*L.R. Schrader*

**CHARWOOD CONDOMINIUMS**  
SITE PLAN

1122845 PA 062

LI 22845 PA 063

SHEET 4 OF 10

# CHARWOOD CONDOMINIUMS UTILITIES PLAN

- LEGEND
- WATER MAIN
  - SANITARY SEWER
  - STORM SEWER



*L.R. Schader*

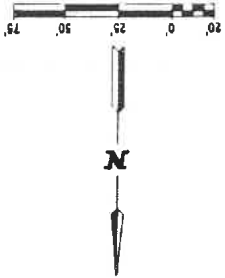
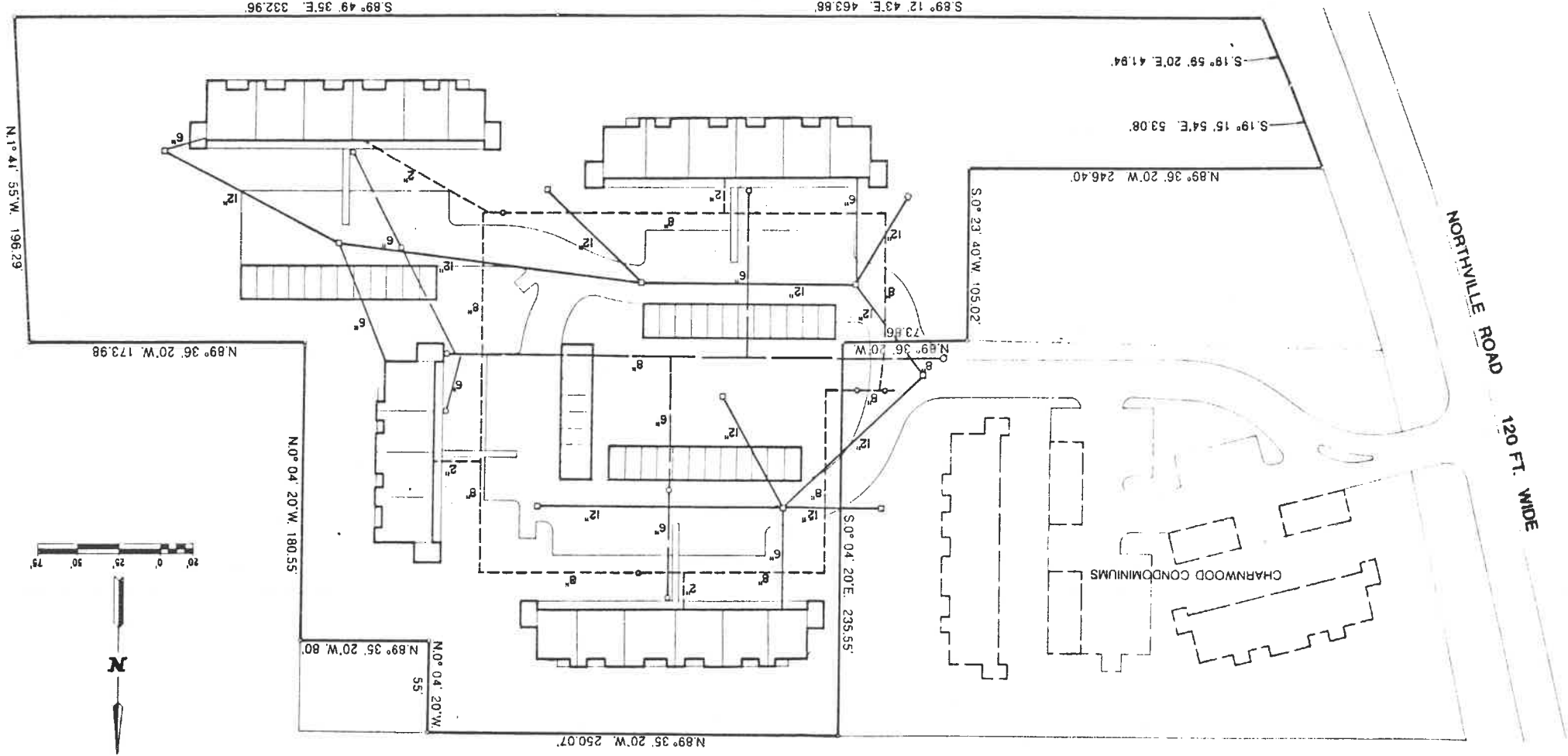

G921017

EASEMENT

L22361 PA263

Charnwood Group

Ving an address of 27830 Orchard Lake Road, Suite #203, Farmington Hills, MI 48018

hereinafter designated "GRANTOR", in consideration of the sum of One Dollar, receipt of which is hereby acknowledged and determined to be fair and just compensation by GRANITOR, as by these presents covenant and warrant that GRANITOR is the fee simple owner of the property described below and does grant and convey to the Plymouth Charter Township, a Michigan municipal corporation. 2350 Ann Arbor Road, Plymouth, Michigan 48170, hereinafter designated "GRANTEE", an easement and right of way for the purpose of installation, inspection, maintenance, repair, operation and removal of municipally owned utilities, including without limitation water, storm sewer and sanitary sewer and connections thereto, in, upon and across the property owned by GRANITOR, situated in the Plymouth Charter Township, Wayne County, Michigan and more particularly described as:

EASEMENT FOR WATER MAIN

A twelve foot wide easement for water main located within a portion of Lot 48, Supervisor's Plymouth Plat No. 3 of Holcomb's Addition To The Village Of Plymouth and part of Section 23, T.1 S., R.8 E., Plymouth Township, Wayne County, Michigan, as recorded in Liber 66, Page 38 of Plats, Wayne County Records.

The centerline of which is described as:

Beginning at a point on the east line of Northville Road (60 feet East of centerline) distant S.89°36'20"E, 28.20 feet along the south line of said lot 48, and northerly an arc distance of 31.29 feet along a curve concave to the east through a central angle of 00°42'55" from the southwest corner of said lot 48; thence S.89°36'20"E, 139.37 feet to a point where easement branches into two legs thence along the left leg N.00°23'40"E, 61.00 feet to the end of this leg; thence along the right leg S.89°36'20"E, 184.00 feet; thence S.00°23'40"W, 30.00 feet to a point on the south line of said lot 48 and the end of this leg.

The GRANTEE, its employees, agents or independent contractors, shall have full right upon said property and ingress and egress thereto for the purpose of constructing, installing, maintaining, repairing, altering or removing the aforementioned facilities. Further, for the purpose of storing or moving machinery, materials or other incidentals in connection with and during the construction or maintenance of said work, GRANTEE, its employees, agents or independent contractors, shall have a right of access and egress over and across adjoining lands of GRANITOR. Reasonable caution shall be observed by GRANTEE, its employees, agents and independent contractors, for the protection of trees, shrubs, fences and other improvements belonging to GRANITOR. All surplus earth shall be removed from the property or deposited on the property in a manner satisfactory to GRANITOR. Upon completion of installation, construction, maintenance, repairs, alteration or removal of said facilities, the premises shall be left as nearly as reasonably possible in the same condition as before such work began and all machinery, materials and equipment removed.

The granting of the easement as stated herein shall vest in the GRANTEE authority to use said property for the purposes herein designated. This grant of easement shall run with the land and be binding upon the heirs, successors and assigns of GRANITOR and GRANTEE. It is understood and agreed that any and all improvements or expenditures of the municipally owned utilities in the easement premises shall become the responsibility of the GRANTEE, its successors and assigns, and shall be subject to the GRANTEE'S fees, rules, regulations and ordinances.

G921017

IN WITNESS WHEREOF, GRANTOR has executed this instrument on May 15, 1984.

In the presence of:

Leslie A. Rebtov  
Leslie A. Rebtov  
Kimberlee A. Schalk  
Kimberlee A. Schalk

GRANTOR  
Arthur A. Savoie  
ARTHUR A. SAVOIE, Partner

State of Michigan  
County of Oakland

The foregoing instrument was acknowledged before me this May 15, 1984, by Arthur A. Savoie, a partner of Charnwood Group, a Michigan Co-Partnership.

Leslie A. Rebtov  
Notary Public, Oakland County, Michigan  
My commission expires: LESLIE A. REBTOV  
Notary Public, State of Michigan, Commission Expires Oct. 19, 1987

This instrument drafted by:  
Township Clerk - Esther Hulsing  
Plymouth Charter Township  
42350 Ann Arbor Road  
Plymouth, Michigan 48170

This instrument is exempt from the Michigan transfer tax pursuant to Section 5a, being MCLA 207.505a.  
This instrument approved as to form only by the Attorney for the Plymouth Charter Township, on APRIL 2, 1985.  
C. Brian James  
C. Brian James, Township Attorney

This instrument approved as to form only by Engineer for the Plymouth Charter Township on JANUARY 3, 1985.  
Michael Spaid  
MICHAEL BAILEY, Township Engineer

This instrument accepted by the Board of Trustees of the Plymouth Charter Township at its meeting of April 23, 1985, and directed to be recorded.

PLYMOUTH CHARTER TOWNSHIP  
Esther Hulsing  
Esther Hulsing, Clerk (B)

This instrument after recording return to:  
Township Clerk  
Plymouth Charter Township  
42350 Ann Arbor Road  
Plymouth, Michigan 48170

UNDERNEATH ALL SIGNATURES, THE NAMES MUST BE PRINTED OR TYPED.



E A S E M E N T

22361 PA 265

Charmwood Group

having an address of 27830 Orchard Lake Road, Suite #203, Farmington Hills, MI 48018

hereinafter designated "GRANTOR", in consideration of the sum of One Dollar, receipt of which is hereby acknowledged and determined to be fair and just compensation by GRANTOR, does by these presents covenant and warrant that GRANTOR is the fee simple owner of the property described below and does grant and convey to the Plymouth Charter Township, a Michigan municipal corporation, 42350 Ann Arbor Road, Plymouth, Michigan 48170, hereinafter designated "GRANTEE", an easement and right of way for the purpose of installation, inspection, maintenance, repair, operation and removal of municipally owned utilities, including without limitation water, storm sewer and sanitary sewer and connections thereto, in, upon and across the property owned by GRANTOR, situated in the Plymouth Charter Township, Wayne County, Michigan and more particularly described as:

EASEMENT FOR SANITARY SEWER

A twenty foot wide easement for sanitary sewer located within a portion of Lot 48, Supervisor's Plymouth Plat No. 3 of Holcomb's Addition To The Village Of Plymouth and part of Section 23, T.1 S., R.10 E., Plymouth Township, Wayne County, Michigan, as recorded in Liber 66, Page 38 of Plats, Wayne County Records.

The centerline of which is described as:

Beginning at a point on the east line of Northville Road (60 feet East of centerline) distant S. 89° 36' 20" E., 20.20 feet along the south line of said Lot 48, and northerly in an arc distance of 10.44 feet along a curve concave to the east through a central angle of 90° 14' 19" from the south-west corner of said Lot 48, thence S. 89° 36' 20" E., 273.91 feet to the point of ending.

G921018

The GRANTEE, its employees, agents or independent contractors, shall have full right upon said property and ingress and egress thereto for the purpose of constructing, installing, maintaining, repairing, altering or removing the aforementioned facilities. Further, for the purpose of storing or moving machinery, materials or other incidentals in connection with and during the construction or maintenance of said work, GRANTEE, its employees, agents or independent contractors, shall have a right of access and use over and across adjoining lands of GRANTOR. Reasonable caution shall be observed by GRANTEE, its employees, agents and independent contractors, for the protection of trees, shrubs, fences and other improvements belonging to GRANTOR. All surplus earth shall be removed from the property or deposited on the property in a manner satisfactory to GRANTOR. Upon completion of installation, construction, maintenance, repairs, alteration or removal of said facilities, the premises shall be left as nearly as reasonably possible in the same condition as before such work began and all machinery, materials and equipment removed.

The granting of the easement as stated herein shall vest in the GRANTEE authority to use said property for the purposes herein designated. This grant of easement shall run with the land and be binding upon the heirs, successors and assigns of GRANTOR and GRANTEE. It is understood and agreed that any and all improvements or appurtenances of the municipally owned utilities in the easement premises shall become and remain at all times the property of the GRANTEE, its successors and assigns, and subject to the GRANTEE'S fees, rules, regulations and ordinances.

RECORDED MAY 27, 1985 H. 1136 A  
FORREST E. YOUNGBLOOD, Register of Deeds  
WAYNE COUNTY, MICHIGAN 48226

IN WITNESS WHEREOF, GRANTOR has executed this instrument on June 11, 1984.

GRANTOR **CHARWOOD GROUP**

Arthur A. Savoie, Partner

Leslie A. Rebtov  
Kimberlee A. Schalk

State of Michigan )  
County of Oakland ) ss.

The foregoing instrument was acknowledged before me this June 11, 1984,  
by Arthur A. Savoie, a partner of Charwood Group, a Michigan Co-Partnership

Notary Public, Oakland County, Michigan  
LESLIE A. REBTOV

My commission expires: Oct. 4, 1987  
Notary Public, Oakland County, MI

✓ This instrument drafted by:

Township Clerk - Esther Hulsing  
Plymouth Charter Township  
42350 Ann Arbor Road  
Plymouth, Michigan 48170

This instrument is exempt from the Michigan transfer tax pursuant to Section 5a, being  
MCLA 207.505a.

This instrument approved as to form only by the Attorney for the Plymouth  
Charter Township, on APRIL 2, 1985.

C. Brian James  
C. Brian James, Township Attorney

This instrument approved as to form only by Engineer for the Plymouth Charter Township  
on JANUARY 3, 1985.

Michael J. Baird  
MICHAEL J. BAIRD, Township Engineer

This instrument accepted by the Board of Trustees of the Plymouth Charter Township at  
its meeting of April 23, 1985, and directed to be recorded.

PLYMOUTH CHARTER TOWNSHIP

Esther Hulsing, Clerk

This instrument after recording return to:

Township Clerk  
Plymouth Charter Township  
42350 Ann Arbor Road  
Plymouth, Michigan 48170

UNDERNEATH ALL SIGNATURES, THE NAMES MUST BE PRINTED OR TYPED.

**DOCUMENT WILL BE RETURNED TO NAME AND MAILING ADDRESS INDICATED  
IN THE BOX BELOW. Include name, street and number (or  
P.O. box), city, state and ZIP code.**

Charnwood Condominium Association  
27830 Orchard Lake Road, #203  
Farmington Hills, Michigan 48018

Telephone: \_\_\_\_\_  
Area Code 313  
Number 855-0101

### INFORMATION AND INSTRUCTIONS

1. Submit one original copy of this document. Upon filing, a microfilm copy will be prepared for the records of the Corporation and Securities Bureau. The original copy will be returned to the address appearing in the box above as evidence of filing.  
Since this document must be microfilmed, it is important that the filing be legible. Documents with poor black and white contrast, or otherwise illegible, will be rejected.
2. This document is to be used pursuant to the provisions of Act 162, P.A. of 1982 by one or more persons for the purpose of forming a domestic nonprofit corporation.
3. Article II— The specific purpose for which the corporation is organized must be included. It is not sufficient to state that the corporation may engage in any activity within the purposes for which corporations may be organized under the Act.
4. Article III— Complete item III(1) or III(2) as appropriate, but not both.
5. Article IV— A post office box may not be designated as the street address of the registered office. The mailing address may differ from the address of the registered office only if a post office box address in the same city as the registered office is designated as the mailing address.
6. Article V— The Act requires one or more incorporators. The addresses should include a street number and name (or other designation), city and state.
7. This document is effective on the date approved and filed by the Bureau. A later effective date, no more than 90 days after the date of delivery, may be stated as an additional article.
8. This document must be signed in ink by each incorporator. However, if there are 3 or more incorporators, they may, by resolution adopted at the organizational meeting by a written instrument, designate one of them to sign the articles of incorporation on behalf of all of them. In such event, these articles of incorporation must be accompanied by a copy of the resolution duly certified by the acting secretary at the organizational meeting and a statement must be placed in the articles incorporating that resolution into them.
9. FEES: Filing fee ..... \$10.00  
Franchise fee ..... \$10.00  
Total fees (Make remittance payable to State of Michigan) ..... \$20.00
10. Mail form and fee to:  
Michigan Department of Commerce  
Corporation and Securities Bureau  
Corporation Division  
P.O. Box 30054  
Lansing, MI 48909  
Telephone: (517) 373-0493

**MICHIGAN DEPARTMENT OF COMMERCE — CORPORATION AND SECURITIES BUREAU**  
**(FOR BUREAU USE ONLY)**

										Date Received	
3											
CORPORATION IDENTIFICATION NUMBER						—					

**ARTICLES OF INCORPORATION**  
**For use by Domestic Nonprofit Corporations**  
 (Please read instructions on last page before completing form)

Pursuant to the provisions of Act 162, Public Acts of 1982, the undersigned corporation executes the following Articles:

**ARTICLE I**  
 The name of the corporation is:  
 Charwood Condominium Association

**ARTICLE II**  
 The purpose or purposes for which the corporation is organized are:  
 See attached Exhibit "A".

**ARTICLE III**  
 The corporation is organized upon a \_\_\_\_\_ Non-Stock \_\_\_\_\_ basis.  
(stock or nonstock)

1. If organized on a stock basis, the aggregate number of shares which the corporation has authority to issue is \_\_\_\_\_. If the shares are, or are to be, divided into classes, the designation of each class, the number of shares in each class, and the relative rights, preferences and limitations of the shares of each class are as follows:

Use space below for additional Articles for continuation of previous Article. Please identify any Article being continued or added. Attach additional pages if needed.

ARTICLE VI

The qualifications of members, the manner of their admission to the Association, the termination of membership, and voting by such members shall be as follows:

(a) Each co-owner of a unit in the Condominium shall be a member of the Association, and no other person or entity shall be entitled to membership. The Developer named in the Condominium Master Deed and any successor Developer approved by the State of Michigan shall be a member of the Association until all units have been conveyed to individual purchasers.

(b) Membership in the Association by persons other than the Developer shall be established by acquisition of ownership of a unit in the Condominium and by recording with the Register of Deeds in the County where the Condominium is located a deed or other instrument establishing a change of ownership of the unit and the furnishing of evidence of such change of ownership satisfactory to the Association, the new co-owner thereby becoming a member of the Association and the membership of the prior co-owner thereby being terminated.

(c) The share of a member in the funds and assets of the Association or other rights of membership cannot be assigned, pledged, encumbered or transferred in any manner except as an appurtenance to the Condominium unit.

(d) Voting by members shall be in accordance with the provisions of the Master Deed, Condominium Bylaws and Corporate Bylaws of this Association.

I (We), the incorporator(s) sign my (our) name(s) this \_\_\_\_\_ day of \_\_\_\_\_, 19\_\_\_\_.

\_\_\_\_\_  
Arthur A. Savoie

\_\_\_\_\_  
\_\_\_\_\_  
\_\_\_\_\_  
\_\_\_\_\_  
\_\_\_\_\_

ARTICLE III

2. If organized on a nonstock basis, the description and value of its real property assets are: (if none, insert "none") None.

and the description and value of its personal property assets are: (if none, insert "none") None.

The corporation is to be financed under the following general plan:

By dues from members.

The corporation is organized on a Membership basis.

(membership or directorship)

ARTICLE IV

1. The address of the registered office is:

27830 Orchard Lk. Rd., #203 Farmington Hills, Michigan 48018

(Street Address)

(City)

(ZIP Code)

2. The mailing address of the registered office if different than above:

(P. O. Box) \_\_\_\_\_, Michigan (ZIP Code) \_\_\_\_\_

(P. O. Box)

(City)

(ZIP Code)

3. The name of the resident agent at the registered office is:

Arthur A. Savoie

ARTICLE V

The name(s) and address(es) of all the incorporator(s) is (are) as follows:

Name Residence or Business Address

Arthur A. Savoie 27830 Orchard Lk. Rd., #203

Farmington Hills, MI 48018

ARTICLE II

EXHIBIT "A"

The purpose or purposes for which the corporation is formed are as follows:

- (a) To manage and administer the affairs of and to maintain Charnwood Condominium (hereinafter referred to as the "Condominium")
- (b) To Levy and collect assessments from the members of the Association and to use the proceeds thereof for the purposes of the Association;
- (c) To carry insurance and to collect and allocate the proceeds thereof;
- (d) To rebuild improvements after casualty;
- (e) To contract for and employ persons, firms, or corporations to assist in management, operation, maintenance, and administration of the Condominium;
- (f) To make and enforce reasonable regulations concerning the use and enjoyment of the Condominium;
- (g) To own, maintain and improve, and to buy, sell, convey, assign, mortgage, lease (as Landlord or Tenant), or otherwise grant interests in any real or personal property, whether or not contiguous to the Condominium, for the purpose of providing benefit to the members of the Association and in furtherance of any of the purposes of the Association. Not in limitation of the foregoing, the Association may acquire and own units in the Condominium;
- (h) To borrow money and issue evidences of indebtedness in furtherance of any or all of the objects of its business; to secure the same by mortgage, pledge or other lien;
- (i) To enforce the provisions of the Master Deed, Condominium Bylaws and Corporate Bylaws and of these Articles of Incorporation and such Rules and Regulations of the Association as may hereafter be adopted;
- (j) To do anything required of or permitted to the Association as administrator of the Condominium by the Condominium Master Deed or Bylaws or by Act. No. 59 of Public Acts of Michigan of 1978, as from time to time amended;
- (k) In general, to enter into any kind of activity; to make and perform any contract and to exercise all powers necessary, incidental or convenient to the administration, management, repair, replacement and operation of said Condominium and to the accomplishment of any of the purposes thereof.